

IEEE 802.11 (a/b/g) Digital Standard for R&S[®] Signal Generators Operating Manual



1171.5283.12 – 09



Test & Measurement

Operating Manual

This document describes the following software options:

- R&S®AMU-K48/-K248
1402.6706.02, 1402.8209.02
- R&S®SMATE-K48
1404.6703.02
- R&S®SMBV-K48/-K248
1415.8102.xx, 1415.8302.xx
- R&S®SMJ-K48/-K248
1404.1001.02, 1409.1116.02
- R&S®SMU-K48/-K248
1161.0266.02, 1408.6114.02
- R&S®AFQ-K228
1401.6602.02
- R&S®SFU-K228
2115.2308.02

© 2010 Rohde & Schwarz GmbH & Co. KG

Muehldorfstr. 15, 81671 Munich, Germany

Phone: +49 89 41 29 - 0

Fax: +49 89 41 29 12 164

E-mail: info@rohde-schwarz.com

Internet: <http://www.rohde-schwarz.com>

Subject to change – Data without tolerance limits is not binding.

R&S® is a registered trademark of Rohde & Schwarz GmbH & Co. KG.

Trade names are trademarks of the owners.

The following abbreviations are used throughout this manual: R&S®AMU is abbreviated as R&S AMU, R&S®SMATE is abbreviated as R&S SMATE, R&S®SMBV is abbreviated as R&S SMBV, R&S®SMJ is abbreviated as R&S SMJ, R&S®SMU is abbreviated as R&S SMU, R&S®WinIQSIM2 is abbreviated as R&S WinIQSIM2

Basic Safety Instructions

Always read through and comply with the following safety instructions!

All plants and locations of the Rohde & Schwarz group of companies make every effort to keep the safety standards of our products up to date and to offer our customers the highest possible degree of safety. Our products and the auxiliary equipment they require are designed, built and tested in accordance with the safety standards that apply in each case. Compliance with these standards is continuously monitored by our quality assurance system. The product described here has been designed, built and tested in accordance with the attached EC Certificate of Conformity and has left the manufacturer's plant in a condition fully complying with safety standards. To maintain this condition and to ensure safe operation, you must observe all instructions and warnings provided in this manual. If you have any questions regarding these safety instructions, the Rohde & Schwarz group of companies will be happy to answer them.

Furthermore, it is your responsibility to use the product in an appropriate manner. This product is designed for use solely in industrial and laboratory environments or, if expressly permitted, also in the field and must not be used in any way that may cause personal injury or property damage. You are responsible if the product is used for any intention other than its designated purpose or in disregard of the manufacturer's instructions. The manufacturer shall assume no responsibility for such use of the product.

The product is used for its designated purpose if it is used in accordance with its product documentation and within its performance limits (see data sheet, documentation, the following safety instructions). Using the product requires technical skills and a basic knowledge of English. It is therefore essential that only skilled and specialized staff or thoroughly trained personnel with the required skills be allowed to use the product. If personal safety gear is required for using Rohde & Schwarz products, this will be indicated at the appropriate place in the product documentation. Keep the basic safety instructions and the product documentation in a safe place and pass them on to the subsequent users.

Observing the safety instructions will help prevent personal injury or damage of any kind caused by dangerous situations. Therefore, carefully read through and adhere to the following safety instructions before and when using the product. It is also absolutely essential to observe the additional safety instructions on personal safety, for example, that appear in relevant parts of the product documentation. In these safety instructions, the word "product" refers to all merchandise sold and distributed by the Rohde & Schwarz group of companies, including instruments, systems and all accessories.

Symbols and safety labels

							
Notice, general danger location Observe product documentation	Caution when handling heavy equipment	Danger of electric shock	Warning! Hot surface	PE terminal	Ground	Ground terminal	Be careful when handling electrostatic sensitive devices

					
ON/OFF supply voltage	Standby indication	Direct current (DC)	Alternating current (AC)	Direct/alternating current (DC/AC)	Device fully protected by double (reinforced) insulation

Tags and their meaning

The following signal words are used in the product documentation in order to warn the reader about risks and dangers.

	indicates a hazardous situation which, if not avoided, will result in death or serious injury.
	indicates a hazardous situation which, if not avoided, could result in death or serious injury.
	indicates a hazardous situation which, if not avoided, could result in minor or moderate injury.
	indicates the possibility of incorrect operation which can result in damage to the product. In the product documentation, the word ATTENTION is used synonymously.

These tags are in accordance with the standard definition for civil applications in the European Economic Area. Definitions that deviate from the standard definition may also exist in other economic areas or military applications. It is therefore essential to make sure that the tags described here are always used only in connection with the related product documentation and the related product. The use of tags in connection with unrelated products or documentation can result in misinterpretation and in personal injury or material damage.

Operating states and operating positions

The product may be operated only under the operating conditions and in the positions specified by the manufacturer, without the product's ventilation being obstructed. If the manufacturer's specifications are not observed, this can result in electric shock, fire and/or serious personal injury or death. Applicable local or national safety regulations and rules for the prevention of accidents must be observed in all work performed.

1. Unless otherwise specified, the following requirements apply to Rohde & Schwarz products: predefined operating position is always with the housing floor facing down, IP protection 2X, pollution severity 2, overvoltage category 2, use only indoors, max. operating altitude 2000 m above sea level, max. transport altitude 4500 m above sea level. A tolerance of $\pm 10\%$ shall apply to the nominal voltage and $\pm 5\%$ to the nominal frequency.
2. Do not place the product on surfaces, vehicles, cabinets or tables that for reasons of weight or stability are unsuitable for this purpose. Always follow the manufacturer's installation instructions when installing the product and fastening it to objects or structures (e.g. walls and shelves). An installation that is not carried out as described in the product documentation could result in personal injury or death.
3. Do not place the product on heat-generating devices such as radiators or fan heaters. The ambient temperature must not exceed the maximum temperature specified in the product documentation or in the data sheet. Product overheating can cause electric shock, fire and/or serious personal injury or death.

Electrical safety

If the information on electrical safety is not observed either at all to the extent necessary, electric shock, fire and/or serious personal injury or death may occur.

1. Prior to switching on the product, always ensure that the nominal voltage setting on the product matches the nominal voltage of the AC supply network. If a different voltage is to be set, the power fuse of the product may have to be changed accordingly.
2. In the case of products of safety class I with movable power cord and connector, operation is permitted only on sockets with an earthing contact and protective earth connection.
3. Intentionally breaking the protective earth connection either in the feed line or in the product itself is not permitted. Doing so can result in the danger of an electric shock from the product. If extension cords or connector strips are implemented, they must be checked on a regular basis to ensure that they are safe to use.
4. If the product does not have a power switch for disconnection from the AC supply network, the plug of the connecting cable is regarded as the disconnecting device. In such cases, always ensure that the power plug is easily reachable and accessible at all times (corresponding to the length of connecting cable, approx. 2 m). Functional or electronic switches are not suitable for providing disconnection from the AC supply network. If products without power switches are integrated into racks or systems, a disconnecting device must be provided at the system level.
5. Never use the product if the power cable is damaged. Check the power cable on a regular basis to ensure that it is in proper operating condition. By taking appropriate safety measures and carefully laying the power cable, you can ensure that the cable will not be damaged and that no one can be hurt by, for example, tripping over the cable or suffering an electric shock.
6. The product may be operated only from TN/TT supply networks fused with max. 16 A (higher fuse only after consulting with the Rohde & Schwarz group of companies).
7. Do not insert the plug into sockets that are dusty or dirty. Insert the plug firmly and all the way into the socket. Otherwise, sparks that result in fire and/or injuries may occur.
8. Do not overload any sockets, extension cords or connector strips; doing so can cause fire or electric shocks.
9. For measurements in circuits with voltages $V_{\text{rms}} > 30 \text{ V}$, suitable measures (e.g. appropriate measuring equipment, fusing, current limiting, electrical separation, insulation) should be taken to avoid any hazards.
10. Ensure that the connections with information technology equipment, e.g. PCs or other industrial computers, comply with the IEC60950-1/EN60950-1 or IEC61010-1/EN 61010-1 standards that apply in each case.
11. Unless expressly permitted, never remove the cover or any part of the housing while the product is in operation. Doing so will expose circuits and components and can lead to injuries, fire or damage to the product.
12. If a product is to be permanently installed, the connection between the PE terminal on site and the product's PE conductor must be made first before any other connection is made. The product may be installed and connected only by a licensed electrician.
13. For permanently installed equipment without built-in fuses, circuit breakers or similar protective devices, the supply circuit must be fused in such a way that anyone who has access to the product, as well as the product itself, is adequately protected from injury or damage.

Basic Safety Instructions

14. Use suitable overvoltage protection to ensure that no overvoltage (such as that caused by a bolt of lightning) can reach the product. Otherwise, the person operating the product will be exposed to the danger of an electric shock.
15. Any object that is not designed to be placed in the openings of the housing must not be used for this purpose. Doing so can cause short circuits inside the product and/or electric shocks, fire or injuries.
16. Unless specified otherwise, products are not liquid-proof (see also section "Operating states and operating positions", item 1. Therefore, the equipment must be protected against penetration by liquids. If the necessary precautions are not taken, the user may suffer electric shock or the product itself may be damaged, which can also lead to personal injury.
17. Never use the product under conditions in which condensation has formed or can form in or on the product, e.g. if the product has been moved from a cold to a warm environment. Penetration by water increases the risk of electric shock.
18. Prior to cleaning the product, disconnect it completely from the power supply (e.g. AC supply network or battery). Use a soft, non-linting cloth to clean the product. Never use chemical cleaning agents such as alcohol, acetone or diluents for cellulose lacquers.

Operation

1. Operating the products requires special training and intense concentration. Make sure that persons who use the products are physically, mentally and emotionally fit enough to do so; otherwise, injuries or material damage may occur. It is the responsibility of the employer/operator to select suitable personnel for operating the products.
2. Before you move or transport the product, read and observe the section titled "Transport".
3. As with all industrially manufactured goods, the use of substances that induce an allergic reaction (allergens) such as nickel cannot be generally excluded. If you develop an allergic reaction (such as a skin rash, frequent sneezing, red eyes or respiratory difficulties) when using a Rohde & Schwarz product, consult a physician immediately to determine the cause and to prevent health problems or stress.
4. Before you start processing the product mechanically and/or thermally, or before you take it apart, be sure to read and pay special attention to the section titled "Waste disposal", item 1.
5. Depending on the function, certain products such as RF radio equipment can produce an elevated level of electromagnetic radiation. Considering that unborn babies require increased protection, pregnant women must be protected by appropriate measures. Persons with pacemakers may also be exposed to risks from electromagnetic radiation. The employer/operator must evaluate workplaces where there is a special risk of exposure to radiation and, if necessary, take measures to avert the potential danger.
6. Should a fire occur, the product may release hazardous substances (gases, fluids, etc.) that can cause health problems. Therefore, suitable measures must be taken, e.g. protective masks and protective clothing must be worn.
7. If a laser product (e.g. a CD/DVD drive) is integrated into a Rohde & Schwarz product, absolutely no other settings or functions may be used as described in the product documentation. The objective is to prevent personal injury (e.g. due to laser beams).

Repair and service

1. The product may be opened only by authorized, specially trained personnel. Before any work is performed on the product or before the product is opened, it must be disconnected from the AC supply network. Otherwise, personnel will be exposed to the risk of an electric shock.
2. Adjustments, replacement of parts, maintenance and repair may be performed only by electrical experts authorized by Rohde & Schwarz. Only original parts may be used for replacing parts relevant to safety (e.g. power switches, power transformers, fuses). A safety test must always be performed after parts relevant to safety have been replaced (visual inspection, PE conductor test, insulation resistance measurement, leakage current measurement, functional test). This helps ensure the continued safety of the product.

Batteries and rechargeable batteries/cells

If the information regarding batteries and rechargeable batteries/cells is not observed either at all or to the extent necessary, product users may be exposed to the risk of explosions, fire and/or serious personal injury, and, in some cases, death. Batteries and rechargeable batteries with alkaline electrolytes (e.g. lithium cells) must be handled in accordance with the EN 62133 standard.

1. Cells must not be taken apart or crushed.
2. Cells or batteries must not be exposed to heat or fire. Storage in direct sunlight must be avoided. Keep cells and batteries clean and dry. Clean soiled connectors using a dry, clean cloth.
3. Cells or batteries must not be short-circuited. Cells or batteries must not be stored in a box or in a drawer where they can short-circuit each other, or where they can be short-circuited by other conductive materials. Cells and batteries must not be removed from their original packaging until they are ready to be used.
4. Keep cells and batteries out of the hands of children. If a cell or a battery has been swallowed, seek medical aid immediately.
5. Cells and batteries must not be exposed to any mechanical shocks that are stronger than permitted.
6. If a cell develops a leak, the fluid must not be allowed to come into contact with the skin or eyes. If contact occurs, wash the affected area with plenty of water and seek medical aid.
7. Improperly replacing or charging cells or batteries that contain alkaline electrolytes (e.g. lithium cells) can cause explosions. Replace cells or batteries only with the matching Rohde & Schwarz type (see parts list) in order to ensure the safety of the product.
8. Cells and batteries must be recycled and kept separate from residual waste. Rechargeable batteries and normal batteries that contain lead, mercury or cadmium are hazardous waste. Observe the national regulations regarding waste disposal and recycling.

Transport

1. The product may be very heavy. Therefore, the product must be handled with care. In some cases, the user may require a suitable means of lifting or moving the product (e.g. with a lift-truck) to avoid back or other physical injuries.

2. Handles on the products are designed exclusively to enable personnel to transport the product. It is therefore not permissible to use handles to fasten the product to or on transport equipment such as cranes, fork lifts, wagons, etc. The user is responsible for securely fastening the products to or on the means of transport or lifting. Observe the safety regulations of the manufacturer of the means of transport or lifting. Noncompliance can result in personal injury or material damage.
3. If you use the product in a vehicle, it is the sole responsibility of the driver to drive the vehicle safely and properly. The manufacturer assumes no responsibility for accidents or collisions. Never use the product in a moving vehicle if doing so could distract the driver of the vehicle. Adequately secure the product in the vehicle to prevent injuries or other damage in the event of an accident.

Waste disposal

1. If products or their components are mechanically and/or thermally processed in a manner that goes beyond their intended use, hazardous substances (heavy-metal dust such as lead, beryllium, nickel) may be released. For this reason, the product may only be disassembled by specially trained personnel. Improper disassembly may be hazardous to your health. National waste disposal regulations must be observed.
2. If handling the product releases hazardous substances or fuels that must be disposed of in a special way, e.g. coolants or engine oils that must be replenished regularly, the safety instructions of the manufacturer of the hazardous substances or fuels and the applicable regional waste disposal regulations must be observed. Also observe the relevant safety instructions in the product documentation. The improper disposal of hazardous substances or fuels can cause health problems and lead to environmental damage.

Informaciones elementales de seguridad

Es imprescindible leer y observar las siguientes instrucciones e informaciones de seguridad!

El principio del grupo de empresas Rohde & Schwarz consiste en tener nuestros productos siempre al día con los estándares de seguridad y de ofrecer a nuestros clientes el máximo grado de seguridad. Nuestros productos y todos los equipos adicionales son siempre fabricados y examinados según las normas de seguridad vigentes. Nuestro sistema de garantía de calidad controla constantemente que sean cumplidas estas normas. El presente producto ha sido fabricado y examinado según el certificado de conformidad adjunto de la UE y ha salido de nuestra planta en estado impecable según los estándares técnicos de seguridad. Para poder preservar este estado y garantizar un funcionamiento libre de peligros, el usuario deberá atenerse a todas las indicaciones, informaciones de seguridad y notas de alerta. El grupo de empresas Rohde & Schwarz está siempre a su disposición en caso de que tengan preguntas referentes a estas informaciones de seguridad.





Además queda en la responsabilidad del usuario utilizar el producto en la forma debida. Este producto está destinado exclusivamente al uso en la industria y el laboratorio o, si ha sido expresamente autorizado, para aplicaciones de campo y de ninguna manera deberá ser utilizado de modo que alguna persona/cosa pueda sufrir daño. El uso del producto fuera de sus fines definidos o sin tener en cuenta las instrucciones del fabricante queda en la responsabilidad del usuario. El fabricante no se hace en ninguna forma responsable de consecuencias a causa del mal uso del producto.

Informaciones elementales de seguridad

Se parte del uso correcto del producto para los fines definidos si el producto es utilizado conforme a las indicaciones de la correspondiente documentación del producto y dentro del margen de rendimiento definido (ver hoja de datos, documentación, informaciones de seguridad que siguen). El uso del producto hace necesarios conocimientos técnicos y ciertos conocimientos del idioma inglés. Por eso se debe tener en cuenta que el producto solo pueda ser operado por personal especializado o personas instruidas en profundidad con las capacidades correspondientes. Si fuera necesaria indumentaria de seguridad para el uso de productos de Rohde & Schwarz, encontraría la información debida en la documentación del producto en el capítulo correspondiente. Guarde bien las informaciones de seguridad elementales, así como la documentación del producto, y entréguelas a usuarios posteriores.

Tener en cuenta las informaciones de seguridad sirve para evitar en lo posible lesiones o daños por peligros de toda clase. Por eso es imprescindible leer detalladamente y comprender por completo las siguientes informaciones de seguridad antes de usar el producto, y respetarlas durante el uso del producto. Deberán tenerse en cuenta todas las demás informaciones de seguridad, como p. ej. las referentes a la protección de personas, que encontrarán en el capítulo correspondiente de la documentación del producto y que también son de obligado cumplimiento. En las presentes informaciones de seguridad se recogen todos los objetos que distribuye el grupo de empresas Rohde & Schwarz bajo la denominación de "producto", entre ellos también aparatos, instalaciones así como toda clase de accesorios.

Símbolos y definiciones de seguridad

							
Aviso: punto de peligro general Observar la documentación del producto	Atención en el manejo de dispositivos de peso elevado	Peligro de choque eléctrico	Advertencia: superficie caliente	Conexión a conductor de protección	Conexión a tierra	Conexión a masa	Aviso: Cuidado en el manejo de dispositivos sensibles a la electrostática (ESD)

					
Tensión de alimentación de PUESTA EN MARCHA / PARADA	Indicación de estado de espera (Standby)	Corriente continua (DC)	Corriente alterna (AC)	Corriente continua / Corriente alterna (DC/AC)	El aparato está protegido en su totalidad por un aislamiento doble (reforzado)

Palabras de señal y su significado

En la documentación del producto se utilizan las siguientes palabras de señal con el fin de advertir contra riesgos y peligros.



PELIGRO identifica un peligro inminente con riesgo elevado que provocará muerte o lesiones graves si no se evita.



ADVERTENCIA identifica un posible peligro con riesgo medio de provocar muerte o lesiones (graves) si no se evita.



ATENCIÓN identifica un peligro con riesgo reducido de provocar lesiones leves o moderadas si no se evita.



AVISO indica la posibilidad de utilizar mal el producto y, como consecuencia, dañarlo.

En la documentación del producto se emplea de forma sinónima el término CUIDADO.

Las palabras de señal corresponden a la definición habitual para aplicaciones civiles en el área económica europea. Pueden existir definiciones diferentes a esta definición en otras áreas económicas o en aplicaciones militares. Por eso se deberá tener en cuenta que las palabras de señal aquí descritas sean utilizadas siempre solamente en combinación con la correspondiente documentación del producto y solamente en combinación con el producto correspondiente. La utilización de las palabras de señal en combinación con productos o documentaciones que no les correspondan puede llevar a interpretaciones equivocadas y tener por consecuencia daños en personas u objetos.

Estados operativos y posiciones de funcionamiento

El producto solamente debe ser utilizado según lo indicado por el fabricante respecto a los estados operativos y posiciones de funcionamiento sin que se obstruya la ventilación. Si no se siguen las indicaciones del fabricante, pueden producirse choques eléctricos, incendios y/o lesiones graves con posible consecuencia de muerte. En todos los trabajos deberán ser tenidas en cuenta las normas nacionales y locales de seguridad del trabajo y de prevención de accidentes.

1. Si no se convino de otra manera, es para los productos Rohde & Schwarz válido lo que sigue: como posición de funcionamiento se define por principio la posición con el suelo de la caja para abajo, modo de protección IP 2X, grado de suciedad 2, categoría de sobrecarga eléctrica 2, uso solamente en estancias interiores, utilización hasta 2000 m sobre el nivel del mar, transporte hasta 4500 m sobre el nivel del mar. Se aplicará una tolerancia de $\pm 10\%$ sobre el voltaje nominal y de $\pm 5\%$ sobre la frecuencia nominal.
2. No sitúe el producto encima de superficies, vehículos, estantes o mesas, que por sus características de peso o de estabilidad no sean aptos para él. Siga siempre las instrucciones de instalación del fabricante cuando instale y asegure el producto en objetos o estructuras (p. ej. paredes y estantes). Si se realiza la instalación de modo distinto al indicado en la documentación del producto, pueden causarse lesiones o incluso la muerte.
3. No ponga el producto sobre aparatos que generen calor (p. ej. radiadores o calefactores). La temperatura ambiente no debe superar la temperatura máxima especificada en la documentación del producto o en la hoja de datos. En caso de sobrecalentamiento del producto, pueden producirse choques eléctricos, incendios y/o lesiones graves con posible consecuencia de muerte.

Seguridad eléctrica

Si no se siguen (o se siguen de modo insuficiente) las indicaciones del fabricante en cuanto a seguridad eléctrica, pueden producirse choques eléctricos, incendios y/o lesiones graves con posible consecuencia de muerte.

1. Antes de la puesta en marcha del producto se deberá comprobar siempre que la tensión preseleccionada en el producto coincida con la de la red de alimentación eléctrica. Si es necesario modificar el ajuste de tensión, también se deberán cambiar en caso dado los fusibles correspondientes del producto.
2. Los productos de la clase de protección I con alimentación móvil y enchufe individual solamente podrán enchufarse a tomas de corriente con contacto de seguridad y con conductor de protección conectado.
3. Queda prohibida la interrupción intencionada del conductor de protección, tanto en la toma de corriente como en el mismo producto. La interrupción puede tener como consecuencia el riesgo de que el producto sea fuente de choques eléctricos. Si se utilizan cables alargadores o regletas de enchufe, deberá garantizarse la realización de un examen regular de los mismos en cuanto a su estado técnico de seguridad.
4. Si el producto no está equipado con un interruptor para desconectarlo de la red, se deberá considerar el enchufe del cable de conexión como interruptor. En estos casos se deberá asegurar que el enchufe siempre sea de fácil acceso (de acuerdo con la longitud del cable de conexión, aproximadamente 2 m). Los interruptores de función o electrónicos no son aptos para el corte de la red eléctrica. Si los productos sin interruptor están integrados en bastidores o instalaciones, se deberá colocar el interruptor en el nivel de la instalación.
5. No utilice nunca el producto si está dañado el cable de conexión a red. Compruebe regularmente el correcto estado de los cables de conexión a red. Asegúrese, mediante las medidas de protección y de instalación adecuadas, de que el cable de conexión a red no pueda ser dañado o de que nadie pueda ser dañado por él, p. ej. al tropezar o por un choque eléctrico.
6. Solamente está permitido el funcionamiento en redes de alimentación TN/TT aseguradas con fusibles de 16 A como máximo (utilización de fusibles de mayor amperaje solo previa consulta con el grupo de empresas Rohde & Schwarz).
7. Nunca conecte el enchufe en tomas de corriente sucias o llenas de polvo. Introduzca el enchufe por completo y fuertemente en la toma de corriente. La no observación de estas medidas puede provocar chispas, fuego y/o lesiones.
8. No sobrecargue las tomas de corriente, los cables alargadores o las regletas de enchufe ya que esto podría causar fuego o choques eléctricos.
9. En las mediciones en circuitos de corriente con una tensión $U_{\text{eff}} > 30 \text{ V}$ se deberán tomar las medidas apropiadas para impedir cualquier peligro (p. ej. medios de medición adecuados, seguros, limitación de tensión, corte protector, aislamiento etc.).
10. Para la conexión con dispositivos informáticos como un PC o un ordenador industrial, debe comprobarse que éstos cumplan los estándares IEC60950-1/EN60950-1 o IEC61010-1/EN 61010-1 válidos en cada caso.
11. A menos que esté permitido expresamente, no retire nunca la tapa ni componentes de la carcasa mientras el producto esté en servicio. Esto pone a descubierto los cables y componentes eléctricos y puede causar lesiones, fuego o daños en el producto.

12. Si un producto se instala en un lugar fijo, se deberá primero conectar el conductor de protección fijo con el conductor de protección del producto antes de hacer cualquier otra conexión. La instalación y la conexión deberán ser efectuadas por un electricista especializado.
13. En el caso de dispositivos fijos que no estén provistos de fusibles, interruptor automático ni otros mecanismos de seguridad similares, el circuito de alimentación debe estar protegido de modo que todas las personas que puedan acceder al producto, así como el producto mismo, estén a salvo de posibles daños.
14. Todo producto debe estar protegido contra sobretensión (debida p. ej. a una caída del rayo) mediante los correspondientes sistemas de protección. Si no, el personal que lo utilice quedará expuesto al peligro de choque eléctrico.
15. No debe introducirse en los orificios de la caja del aparato ningún objeto que no esté destinado a ello. Esto puede producir cortocircuitos en el producto y/o puede causar choques eléctricos, fuego o lesiones.
16. Salvo indicación contraria, los productos no están impermeabilizados (ver también el capítulo "Estados operativos y posiciones de funcionamiento", punto 1). Por eso es necesario tomar las medidas necesarias para evitar la entrada de líquidos. En caso contrario, existe peligro de choque eléctrico para el usuario o de daños en el producto, que también pueden redundar en peligro para las personas.
17. No utilice el producto en condiciones en las que pueda producirse o ya se hayan producido condensaciones sobre el producto o en el interior de éste, como p. ej. al desplazarlo de un lugar frío a otro caliente. La entrada de agua aumenta el riesgo de choque eléctrico.
18. Antes de la limpieza, desconecte por completo el producto de la alimentación de tensión (p. ej. red de alimentación o batería). Realice la limpieza de los aparatos con un paño suave, que no se deshilache. No utilice bajo ningún concepto productos de limpieza químicos como alcohol, acetona o diluyentes para lacas nitrocelulósicas.

Funcionamiento

1. El uso del producto requiere instrucciones especiales y una alta concentración durante el manejo. Debe asegurarse que las personas que manejen el producto estén a la altura de los requerimientos necesarios en cuanto a aptitudes físicas, psíquicas y emocionales, ya que de otra manera no se pueden excluir lesiones o daños de objetos. El empresario u operador es responsable de seleccionar el personal usuario apto para el manejo del producto.
2. Antes de desplazar o transportar el producto, lea y tenga en cuenta el capítulo "Transporte".
3. Como con todo producto de fabricación industrial no puede quedar excluida en general la posibilidad de que se produzcan alergias provocadas por algunos materiales empleados, los llamados alérgenos (p. ej. el níquel). Si durante el manejo de productos Rohde & Schwarz se producen reacciones alérgicas, como p. ej. irritaciones cutáneas, estornudos continuos, enrojecimiento de la conjuntiva o dificultades respiratorias, debe avisarse inmediatamente a un médico para investigar las causas y evitar cualquier molestia o daño a la salud.
4. Antes de la manipulación mecánica y/o térmica o el desmontaje del producto, debe tenerse en cuenta imprescindiblemente el capítulo "Eliminación", punto 1.

5. Ciertos productos, como p. ej. las instalaciones de radiocomunicación RF, pueden a causa de su función natural, emitir una radiación electromagnética aumentada. Deben tomarse todas las medidas necesarias para la protección de las mujeres embarazadas. También las personas con marcapasos pueden correr peligro a causa de la radiación electromagnética. El empresario/operador tiene la obligación de evaluar y señalar las áreas de trabajo en las que exista un riesgo elevado de exposición a radiaciones.
6. Tenga en cuenta que en caso de incendio pueden desprenderse del producto sustancias tóxicas (gases, líquidos etc.) que pueden generar daños a la salud. Por eso, en caso de incendio deben usarse medidas adecuadas, como p. ej. máscaras antigás e indumentaria de protección.
7. En caso de que un producto Rohde & Schwarz contenga un producto láser (p. ej. un lector de CD/DVD), no debe usarse ninguna otra configuración o función aparte de las descritas en la documentación del producto, a fin de evitar lesiones (p. ej. debidas a irradiación láser).

Reparación y mantenimiento

1. El producto solamente debe ser abierto por personal especializado con autorización para ello. Antes de manipular el producto o abrirlo, es obligatorio desconectarlo de la tensión de alimentación, para evitar toda posibilidad de choque eléctrico.
2. El ajuste, el cambio de partes, el mantenimiento y la reparación deberán ser efectuadas solamente por electricistas autorizados por Rohde & Schwarz. Si se reponen partes con importancia para los aspectos de seguridad (p. ej. el enchufe, los transformadores o los fusibles), solamente podrán ser sustituidos por partes originales. Después de cada cambio de partes relevantes para la seguridad deberá realizarse un control de seguridad (control a primera vista, control del conductor de protección, medición de resistencia de aislamiento, medición de la corriente de fuga, control de funcionamiento). Con esto queda garantizada la seguridad del producto.

Baterías y acumuladores o celdas

Si no se siguen (o se siguen de modo insuficiente) las indicaciones en cuanto a las baterías y acumuladores o celdas, pueden producirse explosiones, incendios y/o lesiones graves con posible consecuencia de muerte. El manejo de baterías y acumuladores con electrolitos alcalinos (p. ej. celdas de litio) debe seguir el estándar EN 62133.

1. No deben desmontarse, abrirse ni triturarse las celdas.
2. Las celdas o baterías no deben someterse a calor ni fuego. Debe evitarse el almacenamiento a la luz directa del sol. Las celdas y baterías deben mantenerse limpias y secas. Limpiar las conexiones sucias con un paño seco y limpio.
3. Las celdas o baterías no deben cortocircuitarse. Es peligroso almacenar las celdas o baterías en estuches o cajones en cuyo interior puedan cortocircuitarse por contacto recíproco o por contacto con otros materiales conductores. No deben extraerse las celdas o baterías de sus embalajes originales hasta el momento en que vayan a utilizarse.
4. Mantener baterías y celdas fuera del alcance de los niños. En caso de ingestión de una celda o batería, avisar inmediatamente a un médico.
5. Las celdas o baterías no deben someterse a impactos mecánicos fuertes indebidos.

Informaciones elementales de seguridad

6. En caso de falta de estanqueidad de una celda, el líquido vertido no debe entrar en contacto con la piel ni los ojos. Si se produce contacto, lavar con agua abundante la zona afectada y avisar a un médico.
7. En caso de cambio o recarga inadecuados, las celdas o baterías que contienen electrolitos alcalinos (p. ej. las celdas de litio) pueden explotar. Para garantizar la seguridad del producto, las celdas o baterías solo deben ser sustituidas por el tipo Rohde & Schwarz correspondiente (ver lista de recambios).
8. Las baterías y celdas deben reciclarse y no deben tirarse a la basura doméstica. Las baterías o acumuladores que contienen plomo, mercurio o cadmio deben tratarse como residuos especiales. Respete en esta relación las normas nacionales de eliminación y reciclaje.

Transporte

1. El producto puede tener un peso elevado. Por eso es necesario desplazarlo o transportarlo con precaución y, si es necesario, usando un sistema de elevación adecuado (p. ej. una carretilla elevadora), a fin de evitar lesiones en la espalda u otros daños personales.
2. Las asas instaladas en los productos sirven solamente de ayuda para el transporte del producto por personas. Por eso no está permitido utilizar las asas para la sujeción en o sobre medios de transporte como p. ej. grúas, carretillas elevadoras de horquilla, carros etc. Es responsabilidad suya fijar los productos de manera segura a los medios de transporte o elevación. Para evitar daños personales o daños en el producto, siga las instrucciones de seguridad del fabricante del medio de transporte o elevación utilizado.
3. Si se utiliza el producto dentro de un vehículo, recae de manera exclusiva en el conductor la responsabilidad de conducir el vehículo de manera segura y adecuada. El fabricante no asumirá ninguna responsabilidad por accidentes o colisiones. No utilice nunca el producto dentro de un vehículo en movimiento si esto pudiera distraer al conductor. Asegure el producto dentro del vehículo debidamente para evitar, en caso de un accidente, lesiones u otra clase de daños.

Eliminación

1. Si se trabaja de manera mecánica y/o térmica cualquier producto o componente más allá del funcionamiento previsto, pueden liberarse sustancias peligrosas (polvos con contenido de metales pesados como p. ej. plomo, berilio o níquel). Por eso el producto solo debe ser desmontado por personal especializado con formación adecuada. Un desmontaje inadecuado puede ocasionar daños para la salud. Se deben tener en cuenta las directivas nacionales referentes a la eliminación de residuos.
2. En caso de que durante el trato del producto se formen sustancias peligrosas o combustibles que deban tratarse como residuos especiales (p. ej. refrigerantes o aceites de motor con intervalos de cambio definidos), deben tenerse en cuenta las indicaciones de seguridad del fabricante de dichas sustancias y las normas regionales de eliminación de residuos. Tenga en cuenta también en caso necesario las indicaciones de seguridad especiales contenidas en la documentación del producto. La eliminación incorrecta de sustancias peligrosas o combustibles puede causar daños a la salud o daños al medio ambiente.

Contents

1	Preface	5
1.1	Documentation Overview.....	5
1.2	Typographical Conventions.....	6
2	Introduction	7
2.1	Physical Layer OFDM.....	8
2.1.1	PLCP Format.....	9
2.1.2	PLCP Preamble.....	9
2.1.3	Signal Field.....	10
2.1.4	User Data.....	10
2.2	Physical Layer CCK-PBCC.....	11
2.2.1	Long PLCP PPDU Format.....	12
2.2.2	Short PLCP PPDU Format.....	12
2.3	Data Spreading and Modulation CCK-PBCC.....	13
2.3.1	1 Mbps Data Rate with DBPSK Modulation.....	14
2.3.2	2 Mbps Data Rate with DQPSK Modulation.....	14
2.3.3	5.5 Mbps Data Rate with CCK Modulation.....	15
2.3.4	11 Mbps Data Rate with CCK Modulation.....	16
2.3.5	5.5 Mbps and 11 Mbps Data Rates with PBCC Modulation.....	16
2.3.6	22 Mbps and 33 Mbps Data Rates with PBCC Modulation.....	17
3	WLAN User Interface	18
3.1	General Settings for WLAN Signals.....	19
3.2	PPDU/Sequence Configuration.....	24
3.2.1	Standard 802.11a - OFDM.....	24
3.2.2	Standard 802.11b/g - CCK - PBCC.....	25
3.2.3	Settings.....	26
3.3	MAC Header and FCS Configuration.....	31
3.4	PPDU Graph.....	34
3.5	Filter/Clipping Settings.....	35
3.5.1	Filter Settings.....	35
3.5.2	Clipping Settings.....	37
3.6	Trigger/Marker/Clock Settings.....	38

3.6.1	Trigger In.....	39
3.6.2	Marker Mode.....	43
3.6.3	Marker Delay.....	44
3.6.4	Clock Settings.....	45
3.6.5	Global Settings.....	46
4	Remote-Control Commands.....	48
4.1	General Commands.....	48
4.2	Filter/Clipping Settings.....	57
4.3	Trigger Settings.....	63
4.4	Marker Settings.....	70
4.5	Clock Settings.....	74
4.6	PSDU Settings.....	77
	List of Commands.....	86
	Index.....	88

1 Preface

1.1 Documentation Overview

The user documentation for the R&S Signal Generator consists of the following parts:

- Online Help system on the instrument,
- "Quick Start Guide" printed manual,
- Documentation CD-ROM with:
 - Online help system (*.chm) as a standalone help,
 - Operating Manuals for base unit and options,
 - Service Manual,
 - Data sheet and specifications,
 - Links to useful sites on the R&S internet.

Online Help

The Online Help is embedded in the instrument's firmware. It offers quick, context-sensitive access to the complete information needed for operation and programming. The online help contains help on operating the R&S Signal Generator and all available options.

Quick Start Guide

This manual is delivered with the instrument in printed form and in PDF format on the Documentation CD-ROM. It provides the information needed to set up and start working with the instrument. Basic operations and an example of setup are described. The manual includes also general information, e.g., Safety Instructions.

Operating Manuals

The Operating Manuals are a supplement to the Quick Start Guide. Operating Manuals are provided for the base unit and each additional (software) option.

These manuals are available in PDF format - in printable form - on the Documentation CD-ROM delivered with the instrument. In the Operating Manual for the base unit, all instrument functions are described in detail. Furthermore, it provides an introduction to remote control and a complete description of the remote control commands with programming examples. Information on maintenance, instrument interfaces and error messages is also given.

In the individual option manuals, the specific instrument functions of the option are described in detail. For additional information on default settings and parameters, refer to the data sheets. Basic information on operating the R&S Signal Generator is not included in the option manuals.

These manuals can also be ordered in printed form (see ordering information in the data sheet).

Service Manual

This Service Manual is available in PDF format - in printable form - on the Documentation CD-ROM delivered with the instrument. It describes how to check compliance with rated specifications, on instrument function, repair, troubleshooting and fault elimination. It contains all information required for repairing the instrument by the replacement of modules.

This manual can also be orderd in printed form (see ordering information in the data sheet).

Release Notes

The release notes describe new and modified functions, eliminated problems, and last minute changes to the documentation. The corresponding firmware version is indicated on the title page of the release notes. The current release notes are provided in the Internet.

1.2 Typographical Conventions

The following text markers are used throughout this documentation:

Convention	Description
"Graphical user interface elements"	All names of graphical user interface elements on the screen, such as dialog boxes, menus, options, buttons, and softkeys are enclosed by quotation marks.
KEYS	Key names are written in capital letters.
File names, commands, program code	File names, commands, coding samples and screen output are distinguished by their font.
<i>Input</i>	Input to be entered by the user is displayed in italics.
Links	Links that you can click are displayed in blue font.
"References"	References to other parts of the documentation are enclosed by quotation marks.

2 Introduction

The R&S Signal Generator provides you with the ability to generate signals in accordance with the Wireless LAN standards IEEE 802.11a, IEEE 802.11b and IEEE 802.11g. (IEEE 802.11) standard WLAN.

'IEEE 802.11' stands for a wireless LAN standard prepared by ANSI/IEEE Institute of Electrical and Electronics Engineers). A brief description of the standard is given in the following. For a detailed description see the corresponding ANSI/IEEE specifications.

In 1990, IEEE founded the work group 802.11 which issued a first version of the 802.11 standard in June 1997. This standard defines two transmission methods: an infrared interface and radio transmission in the ISM band around 2.4 GHz.

Radio transmission can alternatively be carried out via frequency hopping spread spectrum (FHSS) or direct sequence spread spectrum (DSSS).

Originally, two data transmission modes were defined for the DSSS method.

- 1 Mbps data rate with DBPSK modulation
- 2 Mbps data rate with DQPSK modulation

Both modes spread the information data sequence with an 11-chip Barker sequence, and operate with a chip rate of 11 Mcps.

In spring 1999, the standard was extended by an OFDM mode, 802.11a, in the 5 GHz band. Soon afterwards, in summer 1999, the DSSS mode was extended, too. This expansion to include the new data rates of 5.5 Mbps and 11 Mbps is defined in the 802.11b standard. A new modulation mode, complementary code keying (CCK), was introduced (see following sections).

Standard 802.11g issued in 2003 extends standard 802.11b with higher transmission rates. It includes the previous 802.11b standard and implements the OFDM transmission of standard 802.11a in the 2.4 GHz ISM band. In the physical layer, the packet structure and modulation format of the OFDM modes are identical in 802.11g and 802.11a, only different transmission frequencies are used.

The 802.11 wireless LAN standard is a packet-oriented method for data transfer. The data packets are transmitted and received on the same frequency in time division duplex (TDD), but without a fixed timeslot raster. An 802.11 component can only transmit or only receive packets at any particular time.

The R&S Signal Generator simulates IEEE 802.11a-g WLAN at the physical on the physical layer. Two simulation modes are offered:

In the framed mode a sequence of data packets with the frame structure defined by the standard is generated. A MAC header and a frame check sequence can be activated. In the unframed time mode a non-packet-oriented signal without frame structure is generated, with the modulation modes and data rates defined by the IEEE 802.11.

The following list gives an overview of the options provided by the R&S Signal Generator for generating a IEEE 802.11a-g WLAN signal:

- Physical Layer modes OFDM (IEEE.802.11a/g), and CCK/PBCC (IEEE.802.11b/g).

- Chip/Sample rate 20 Mcps (OFDM IEEE.802.11a/g), and 11 Mcps (CCK/PBCC IEEE.802.11b/g).
- PSDU bit rates 1Mbps, 2Mbps, 5.5Mbps and 11 Mbps (CCK/PBCC), 22Mbps (PBCC), 6 Mbps, 9 Mbps, 12 Mbps, 18 Mbps, 24Mbps, 36 Mbps, 48 Mbps and 54 Mbps (OFDM).
- PSDU Modulation DBPSK,DQPSK and CCK/PBCC (CCK/PBCC) and BPSK,QPSK, 16QAM or 64QAM (OFDM) (depending on specified PSDU bit rate).
- Data scrambling can be activated or deactivated (CCK/PBCC) and initial scrambler state can be set randomly or to a user-defined value (OFDM).
- Clipping for reducing the crest factor.

2.1 Physical Layer OFDM

The standard defines OFDM (orthogonal frequency division multiplex) with 52 carriers as transmission method. The symbol rate of the modulation on the individual carriers is 250 kHz. A user data rate of up to 54 Mbps at a channel bandwidth of 20 MHz can be obtained by combining 48 useful carriers for data transmission (4 carriers are used for pilots) and using 64QAM for subcarrier modulation. With OFDM, the individual carriers are super-imposed mutually orthogonal, which, in the ideal case, does not cause any intercarrier interference (ICI).

Table 2-1: Parameters of 802.11a/g OFDM modulation

Parameters	Value
Number of data subcarriers	48
Number of pilot subcarriers	4
Total of subcarriers used	52
Subcarrier frequency spacing	0.3125 MHz (= 20 MHz/64)
IFFT/FFT period	3.2 μ s
Guard interval duration	0.8 μ s (TFFT /4)
Symbol interval	4 μ s (TGI + TFFT)
PLCP preamble duration	16 μ s
Subcarrier modulation	BPSK OFDM QPSK OFDM 16QAM OFDM 64QAM OFDM
Error correction code	K = 7 (64 states) convolutional code
Code rates	1/2, 2/3, 3/4
Occupied bandwidth	16.6 MHz
Channel spacing	20 MHz

The table shows the main parameters of OFDM. 64-point IFFT is used to generate the 52 subcarriers. 12 of the 64 possible carriers are not used. One is the carrier in the middle of the band, which would otherwise be impaired by the carrier leakage of the I/Q modulator, the others are the remaining carriers at the upper and lower end of the spectrum. The required subcarrier offset of 312.5 kHz is implicitly observed when the time signal generated by the IFFT with a sampling rate of 20 MHz is output. These 20 MHz are also called 'kernel sample rate'. An OFDM symbol generated in this way would have a period of 3.2 μ s. To compensate for multipath propagation, a so-called guard interval with a duration of 0.8 μ s is attached to each symbol so that a total symbol interval of 4 μ s is obtained.

Either BPSK, QPSK, 16QAM or 64QAM modulation can be used on the subcarriers. Prior to the modulation, the raw data are convolutionally coded with code rates of $\frac{1}{2}$ to $\frac{3}{4}$ being possible.

The frame structure can be seen in the figure below (also indicated in the "PPDU Configuration" dialog):

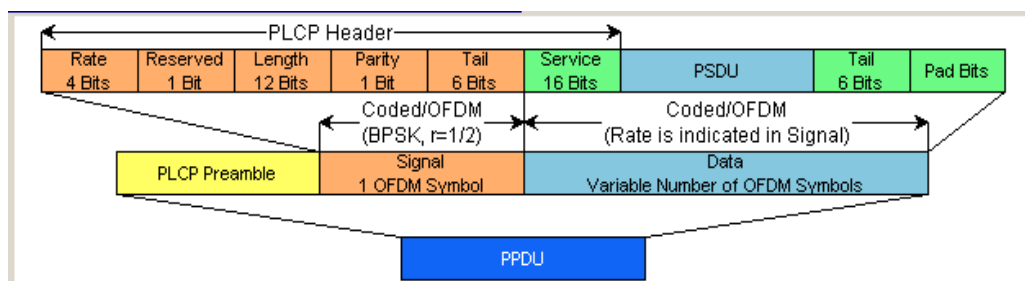

2.1.1 PLCP Format

The physical layer convergence protocol (PLCP) is a protocol layer between medium access control and the actual physical transmission layer (PHY). It is mainly used to adapt the different transmission formats of the 802.11 standards to the MAC layer which is identical for all transmission methods. Moreover, this protocol informs the receiver on the type of signal sent to allow for a correct demodulation.

The PLCP generates the PLCP protocol data unit (PPDU) frames which are physically transmitted.

2.1.2 PLCP Preamble

Each frame starts with the PLCP preamble made up of 10 short and 2 long symbols. The receiver uses the short symbols mainly for signal detection, AGC, coarse frequency adjustment and time synchronization. The long symbols are used to determine the transmission function of the channel and to set the equalizer of the receiver accordingly. The complete preamble is 16 μ s long and thus corresponds to the duration of 4 normal OFDM symbols.

2.1.3 Signal Field

The signal field directly follows the preamble and consists of 24 bits which are used as follows:

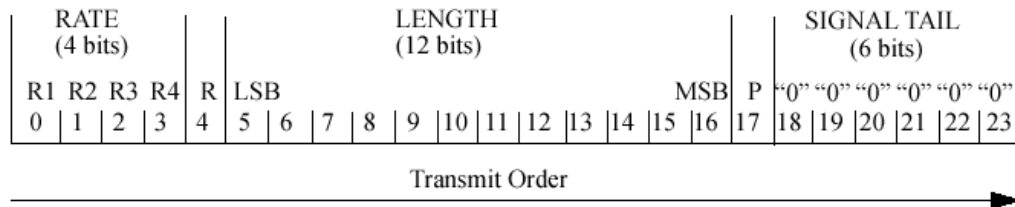

The first 4 bits inform on the data rate (RATE) of the following data section. This allows the receiver to correctly set its demodulator. Following a reserved bit, 12 LENGTH bits are sent. They contain the number of bytes transmitted in this frame. After a parity bit, 6 tail bits reset the convolutional coder to zero.

With settings for 6 Mbps, the 24 bits are subjected to usual signal processing consisting of convolutional coding, interleaving, BPSK subcarrier modulation, pilot carrier generation and OFDM modulation and thus form exactly one OFDM symbol of 4 μ s duration. Thanks to the use of the lowest data rate (6 Mbps), each receiver has the best chance to obtain the information required for subsequent demodulation of the data section.

2.1.4 User Data

The user data in the data section of the frame is finally taken to the receiver. The data section may have a variable length of OFDM symbols and can be transmitted with one of the defined data rates between 6 and 54 Mbps. The data section of the frame is subdivided into the fields SERVICE, PSDU, TAIL and Pad bits.

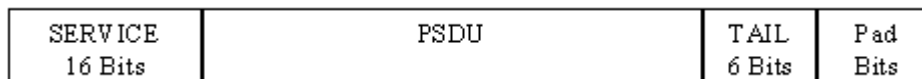

The service field consists of 16 bits, the 7 LSBs transmitted first being 0. This allows the receiver to draw conclusions as to the start value of the scrambler in the transmitter. The remaining 9 bits are reserved and, according to the current version of the standard, should also be set to 0.

The PSDU may have a user-selectable length of up to 2346 bytes. 6 tail bits follow to reset the convolutional coder to zero. The data field must be filled with the full number of OFDM symbols and is therefore rounded up. Additional bits that may be available are set to 0 as pad bits.

A short description of the individual steps required to attain a valid 802.11a/g signal follows.

Data from the source (usually the next higher protocol layer, here MAC) must first be scrambled, i.e. multiplied with a PN sequence. A 127-bit code generated by the following generator polynomial is stipulated:

$$S(x) = x^7 + x^4 + 1$$

A feedback shift register generates the scrambling sequence. The start value of the register for the data section should be randomly selected.

A subsequent convolutional coder adds redundancies to the bits thus scrambled (factor of 2). The coder has 64 possible states ($k = 7$) and is described by the polynomials $g_0=133_8$ and $g_1=171_8$. To obtain the data rates of 6 to 54 Mbps defined by the standard, different channel code rates are required. Bits generated by the convolutional coder are therefore punctured (i.e. omitted) depending on the setting so that 1/2, 2/3 or 3/4 code rates are attained. Increasing the redundancy by channel coding is generally mandatory in case of OFDM modulations since complete subcarriers may be eliminated by frequency selective fading so that the loss of bits on the transmission path is in many cases unavoidable.

To increase the performance of the convolutional coder, the coded data are interleaved in the next step. Two interleaver stages ensure that the adjacent bits of the convolutional coder are first distributed to different subcarriers and then to higher- or lower-significant bits of the constellation used for subcarrier modulation. Long sequences of defective bits can thus be avoided which significantly improves the faculties of the Viterbi decoder in the receiver for a correction.

The next stage performs the actual modulation of the individual OFDM carriers. Depending on the set data rate, the useful carriers are subjected to a uniform BPSK, QPSK, 16QAM or 64QAM modulation. This is done by first calculating the I and Q coefficients of each carrier. Gray coding is used to distribute the data bits to constellation points. All carriers from -26 to +26, except carriers -21, -7, 0, 7 and 21, are used for the transmission of user data. Carrier number 0 (directly at the center frequency later on) is not used and is always 0. The remaining 4 are BPSK-modulated pilots. The pilot carriers change their phase with each symbol. The phase variation is determined by the 127-bit PN sequence already defined as scrambling sequence.

The actual OFDM modulation is performed by inverse discrete Fourier transform (IFFT) in the next step. A 64-point IFFT is carried out with the I and Q coefficients of the subcarriers obtained before. To ensure sufficient spacing of aliasing products, only 52 of the 64 possible carriers are used. The result is a discrete complex time signal in the baseband with modulated OFDM carriers. A guard field which corresponds to a periodic continuation of the same symbol is then appended before each OFDM symbol. Multipath propagation can thus be easily compensated in the receiver.

Aliasing products are suppressed by oversampling, converting the discrete digital signal to an analog signal and subsequent filtering. In the last step, the baseband signal is modulated onto the selected RF carrier and the complete signal is sent to the receiver via the air interface.

2.2 Physical Layer CCK-PBCC

A distinction is made between the packet type (or PPDU format) with long or short PLCP (physical layer convergence protocol).

2.2.1 Long PLCP PDU Format

In 802.11, the data packet on the physical layer is referred to as PPDU (PLCP protocol data units). A PPDU consists of three components; the PLCP preamble, the PLCP header and the PSDU (PLCP service data unit), which contains the actual information data (coming from higher layers).

The PLCP preamble and header are used for synchronization and signalling purposes, and are themselves divided into fields.

The PLCP **preamble** consists of a synchronization field and a start frame delimiter field. The standard specifies a fixed data content for both fields.

The PLCP **header** consists of the signal, service, length and CRC fields.

The signal field determines the data rate used in the PSDU field. The rates 1 Mbps, 2 Mbps, 5.5 Mbps, and 11 Mbps can be selected; rates 22 Mbps and 33 Mbps can be used in the optional PBCC modes.

The service field also helps to differentiate the modulation modes (CCK or PBCC) used for the higher data rates of 5.5 Mbps and 11 Mbps.

The length of the PSDU field is entered in μ s in the Length field.

The CRC field contains a check sum of all the fields of the PLCP header.

The PLCP preamble and the PLCP header in the long PLCP PDU format are both DBPSK-modulated and transmitted at a data rate of 1 Mbps. The data rate and the modulation of the PSDU component are defined by the signal and service fields in the PLCP header.

The frame structure can be seen in the figure below (also indicated in the "PPDU Configuration" dialog):

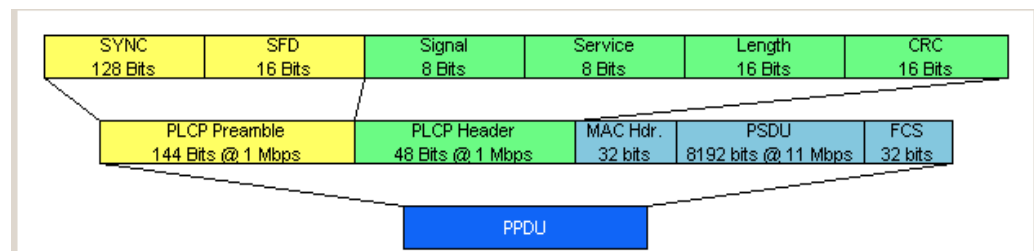

2.2.2 Short PLCP PDU Format

The basic structure of the short PLCP PDU format is identical to that of the long PLCP PDU format. There is no difference in the PSDU component. The PLCP preamble and header are generated in an abbreviated form. In the short preamble, the number of bits transmitted in the SYNC field is reduced from 128 to 56. In the short header, however, the number of data bits transmitted remains unchanged, but the data rate is doubled (to 2 Mbps). These measures halve the transmission periods of preamble and header in the short PLCP format, as compared to the long PLCP format.

The frame structure can be seen in the figure below (also indicated in the "PPDU Configuration" dialog):

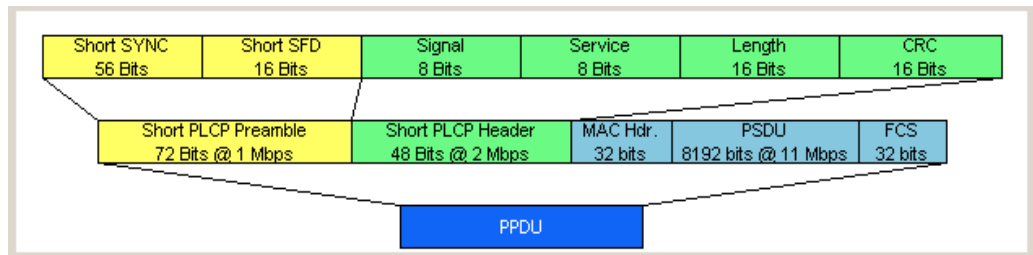

2.3 Data Spreading and Modulation CCK-PBCC

The R&S Signal Generator simulates signals in accordance with 802.11 on the physical layer. In the standard, the data link layer or, to be more precise, the MAC sublayer provides the input data for this layer. The following graph illustrates the signal generation process.

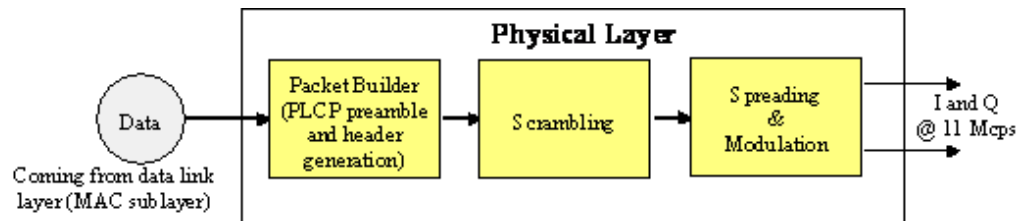

Fig. 2-1: Principle of 802.11b/g signal generation

Depending on the PLCP PDU format used, the PLCP preamble and the PLCP header are combined in the packet builder. The PSDU field of the packet is filled with the input data of the physical layer block. In the next step, all the packet data is scrambled. The actual spreading and modulation of the data signal to the resulting chip rate of 11 Mcps comes next.

However, the data rates and modulations of the individual fields of a packet can differ. The PLCP preamble always has a data rate of 1 Mbps, and is DBPSK-modulated. Besides the actual modulation, spreading to the resulting chip rate occurs.

The PLCP header is either treated exactly like the preamble (long PLCP PDU format), or DQPSK-modulated at a data rate of 2 Mbps (short PLCP PDU format). Data rates (1 Mbps, 2 Mbps, 5.5 Mbps, 11 Mbps, etc) with different modulations can be used for the data part of the packet, the PLCP service data unit (PSDU). The following table gives an overview of the different combinations of data rates, modulations and spreading/coding methods.

Packet field	Data rate	Chip rate	Spreading/coding methods	Modulation
Short PLCP preamble	1 Mbps	11 Mcps	11-chip Barker sequence	DBPSK
Long PLCP preamble	1 Mbps	11 Mcps	11-chip Barker sequence	DBPSK

Packet field	Data rate	Chip rate	Spreading/coding methods	Modulation
Short PLCP header	2 Mbps	11 Mcps	11-chip Barker sequence	DQPSK
Long PLCP header	1 Mbps	11 Mcps	11-chip Barker sequence	DBPSK
PSDU	1 Mbps (long PDU)	11 Mcps	11-chip Barker sequence	DBPSK
PSDU	2 Mbps	11 Mcps	11-chip Barker sequence	DQPSK
PSDU	5.5 Mbps	11 Mcps	CCK	DQPSK
PSDU	11 Mbps	11 Mcps	CCK	DQPSK
PSDU	5.5 Mbps	11 Mcps	PBCC	BPSK
PSDU	11 Mbps	11 Mcps	PBCC	QPSK
PSDU	22 Mbps	11 Mcps	PBCC	8PSK
PSDU	33 Mbps	16.5 Mcps	PBCC	8PSK

The individual combinations of spreading, coding and modulation are described below.

2.3.1 1 Mbps Data Rate with DBPSK Modulation

At a data rate of 1 Mbps, the already scrambled data stream is DBPSK-modulated according to the table below. The resulting symbol sequence is then spread using the 11-chip Barker sequence.

Bit input	Phase change
0	0
1	π

2.3.2 2 Mbps Data Rate with DQPSK Modulation

At a data rate of 2 Mbps, the already scrambled data stream is DQPSK-modulated according to the table below. The resulting symbol sequence is then spread using the 11-chip Barker sequence.

Dibit pattern (d0,d1) (d0 is first in time)	Phase change
00	0
01	$\pi/2$
11	π
10	$3\pi/2(-\pi/2)$

2.3.3 5.5 Mbps Data Rate with CCK Modulation

The standard specifies CCK modulation (complementary code keying) for a data rate of 5.5 Mbps. To this end, in each modulation step, four successive bits (d_0 to d_3) are taken from the data stream which is already scrambled. The phases $\varphi_1, \varphi_2, \varphi_3, \varphi_4$ are determined by these four bits.

φ_1 is determined by the data bits d_0 and d_1 according to the following table, which specifies different phases for even and odd modulation steps:

Dibit pattern (d_0, d_1) (d_0 is first in time)	Even symbols phase change	Odd symbols phase change
00	0	π
01	$\pi/2$	$3\pi/2(-\pi/2)$
11	π	0
10	$3\pi/2(-\pi/2)$	$\pi/2$

The phase φ_1 must be interpreted relative to the phase of the previous symbol.

The other three phases are determined as follows:

$$\varphi_2 = (d_2 - \pi) + \pi/2$$

$$\varphi_3 = 0$$

$$\varphi_4 = d_3 - \pi$$

By means of these four phases, the CCK code word can now be determined; it is:

$$c = \{e^{j(\varphi_1 + \varphi_2 + \varphi_3 + \varphi_4)}, e^{j(\varphi_1 + \varphi_3 + \varphi_4)}, e^{j(\varphi_1 + \varphi_2 + \varphi_4)}, \\ -e^{j(\varphi_1 + \varphi_4)}, e^{j(\varphi_1 + \varphi_2 + \varphi_3)}, e^{j(\varphi_1 + \varphi_3)}, -e^{j(\varphi_1 + \varphi_2)}, e^{j\varphi_1}\}$$

Example:

(d_0 to d_3) = (0110), the phase of the last symbol is 0, the current modulation step is even:

$$\varphi_1 = \pi/2$$

$$\varphi_2 = (1 - \pi) + \pi/2 = 3\pi/2$$

$$\varphi_3 = 0$$

$$\varphi_4 = 0 \cdot \pi = 0$$

The CCK code word is consequently:

$$c = \{e^{j(\pi/2 + 3\pi/2 + 0 + 0)}, e^{j(\pi/2 + 3\pi/2 + 0)}, e^{j(\pi/2 + 3\pi/2 + 0)}, -e^{j(\pi/2 + 0)}, e^{j(\pi/2 + 3\pi/2 + 0)}, e^{j(\pi/2 + 0)}, -e^{j(\pi/2 + 3\pi/2)}, e^{j\pi/2}\}$$

$$c = (e^{j0}, e^{j0}, -e^{j\pi/2}, e^{j0}, e^{j\pi/2}, e^{j0}, e^{j\pi/2}) = (1, 1, 1, -j, 1, j, 1, j)$$

The four data bits (d_0 to d_3) thus become the eight complex output chips (c_0 to c_7).

2.3.4 11 Mbps Data Rate with CCK Modulation

The standard also specifies CCK modulation (complementary code keying) for a data rate of 11 Mbps. The modulation is basically the same as described for the 5.5 Mbps data rate. In each modulation step, eight successive bits (d_0 to d_7) are taken from the data stream, which is already scrambled. The phases $\phi_1, \phi_2, \phi_3, \phi_4$ are determined by these eight bits.

ϕ_1 is determined by the data bits d_0 and d_1 according to the following table, which specifies different phases for even and odd modulation steps:

Dibit pattern (d_0, d_1) (d_0 is first in time)	Even symbols phase change	Odd symbols phase change
00	0	π
01	$\pi/2$	$3\pi/2(-\pi/2)$
11	π	0
10	$3\pi/2(-\pi/2)$	$\pi/2$

The phase ϕ_1 must be interpreted relative to the phase of the previous symbol.

ϕ_2 is determined by the data bits d_2, d_3, ϕ_3 from d_4, d_5 and ϕ_2 from d_6, d_7 according to the following table:

Dibit pattern [d_i, d_{i+1}] (d_0 is first in time)	Phase change
00	0
01	$\pi/2$
11	π
10	$3\pi/2(-\pi/2)$

2.3.5 5.5 Mbps and 11 Mbps Data Rates with PBCC Modulation

Packet binary convolutional coding (PBCC) can optionally be used instead of CCK modulation for the 5.5 Mbps and 11 Mbps data rates. The following illustration provides a schematic overview of this method. For details, refer to the standard.

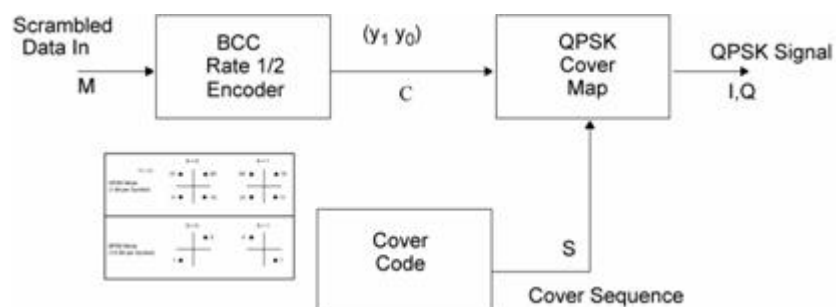
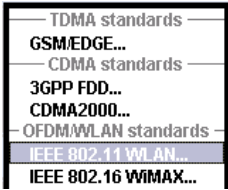

Fig. 2-2: Principle of PBCC modulation

2.3.6 22 Mbps and 33 Mbps Data Rates with PBCC Modulation

802.11g also defines the optional PBCC (ER-PBCC) modes using the extended 22 Mbps and 33 Mbps rates. In contrast to the 5.5 Mbps and 11 Mbps PBCC modes, a rate 2/3 convolutional coder and 8PSK modulation are used. With 33 Mbps, also the clock rate in the data section of the packet is increased to 16.5 Mcps.

3 WLAN User Interface



The menu for setting the IEEE 802.11a-g WLAN digital standard is either called from the baseband block or from the menu tree under Baseband.

The menu is split into several sections for configuring the standard. The choice of simulation mode determines which displays and parameters are made available in the lower section.

The upper section of the menu is where the IEEE 802.11a-g WLAN digital standard is enabled, the default settings are called and the physical layer mode, the simulation mode and the frame type are selected. Additional parameters for defining the signal length and a graph outlining the signal structure are indicated.

A button leads to the submenu for loading and saving the IEEE 802.11a-g WLAN configuration.

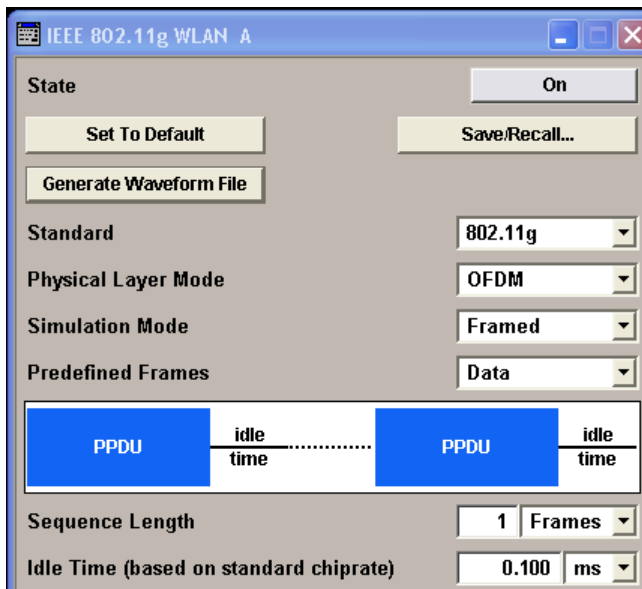

The buttons of the lower menu section lead to submenus for configuring the PPDU and for setting the filter, clipping and marker parameters.

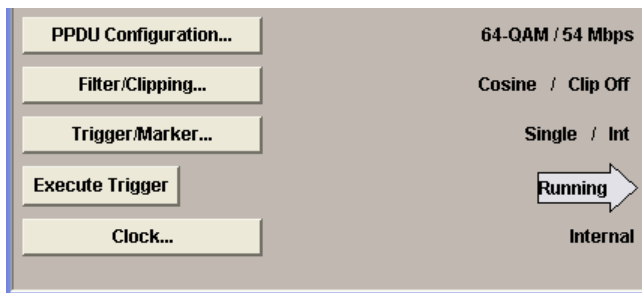

3.1 General Settings for WLAN Signals

The upper menu section is where the IEEE 802.11a-g WLAN digital standard is enabled and the basic signal structure is configured.

State

Enables/disables the IEEE 802.11a-g WLAN standard.

Enabling this standard disables all the other digital standards and digital modulation modes (in case of two-path instruments, this affects the same path).

SCPI command:

[:SOURce<hw>] :BB:WLAN:STATe on page 56

Set to default

Calls the default settings. The following table gives an overview of the settings. The preset value for each parameter is specified in the description of the remote-control commands.

Parameter	Value
State	Not affected by Set to default
Standard	802.11g
Physical Layer Mode	CCK
Simulation Mode	Framed
Predefined Frames	Data
Sequence Length	1 frame
Idle Time	0.1 ms
Filter	Gauss (FSK), 0.50
Chip Rate Variation	11 Mcps
Clipping	Off
PPDU Configuration (CCK)	
PLCP P+H Format	Long PLPC
PSDU Bit Rate (CCK/PBCC)	11 Mbps
Data Length	1024 bytes
PSDU Data Source	PRBS 9
Scrambling	On
Service Field Clock Bits	Locked
MAC Header	Off
FCS (checksum)	Off

SCPI command:

[:SOURce<hw>] :BB:WLAN:PRESet on page 52

Save/Recall

Calls the "Save/Recall" menu.

From the "Save/Recall" menu the File Select windows for saving and recalling IEEE 802.11a-g WLAN configurations and the File Manager can be called.



IEEE 802.11a-g WLAN configurations are stored as files with the predefined file extension *.wlan. The file name and the directory they are stored in are user-definable.

The complete settings in the "IEEE 802.11a-g WLAN" menu are saved and recalled.

- "Recall IEEE 802.11a-g WLAN setting" Opens the "File Select" window for loading a saved IEEE 802.11a-g WLAN configuration. The configuration of the selected (highlighted) file is loaded by pressing the "Select" button.
- "Save IEEE 802.11a-g WLAN setting" Opens the "File Select" window for saving the current IEEE 802.11a-g WLAN signal configuration. The name of the file is specified in the "File name" entry field, the directory selected in the "save into" field. The file is saved by pressing the "Save" button.
- "File Manager" Calls the "File Manager". The "File Manager" is used to copy, delete and rename files and to create new directories.

SCPI command:

[\[:SOURCE<hw>\]:BB:WLAN:SETTING:CATalog](#) on page 53
[\[:SOURCE<hw>\]:BB:WLAN:SETTING:LOAD](#) on page 54
[\[:SOURCE<hw>\]:BB:WLAN:SETTING:STORE](#) on page 54
[\[:SOURCE<hw>\]:BB:WLAN:SETTING:DElete](#) on page 54

Generate Waveform File...

Calls the "Generate Waveform" menu. This menu is used to store the current WLAN signal as ARB signal in a waveform file.

This file can be loaded in the "ARB" menu and processed as multicarrier or multisegment signal.

The file name is entered in the submenu. The file is stored with the predefined file extension *.wv. The file name and the directory it is stored in are user-definable.

SCPI command:

[linktarget doesn't exist but @y.link.required='true'](#)

Standard

Selects the 802.11 standard.

The standard was expanded over the years adding additional features.

- "802.11a" The standard supports OFDM (orthogonal frequency division multiplexing). This modulation is defined by the IEEE 802.11a specification in the 5 GHz frequency band.

- "802.11b" The standard includes the modulation mode CCK (complementary code keying) and the data rates 5.5 Mbps and 11 Mbps. PBCC (packet binary convolutional coding) can optionally be used instead of CCK modulation for the 5.5 Mbps and 11 Mbps data rates.
- "802.11g" Standard 802.11g extends standard 802.11b with higher transmission rates. 802.11g contains the previous 802.11b modes and also integrates the OFDM method used in 802.11a for frequencies in the 2.4 GHz band.

SCPI command:

[\[:SOURCE<hw>\]:BB:WLAN:STANDARD](#) on page 55

Physical Layer Mode

Selects the physical layer mode.

- "OFDM" The OFDM (orthogonal frequency division multiplexing) physical layer supports a frame-based transmission. The OFDM signal is divided into 52 carriers. The symbol rate of the modulation on the individual carriers is 250 kHz. A user data rate of up to 54 Mbps at a channel bandwidth of 20 MHz can be obtained by combining 48 useful carriers for data transmission (4 carriers are used for pilots) and using 64QAM for subcarrier modulation. With OFDM, the individual carriers are superimposed mutually orthogonal, which, in the ideal case, does not cause any intercarrier interference (ICI).
- "CCK" The CCK (complementary code keying) physical layer mode is used for the 5.5 Mbps and 11 Mbps data rates.
- "PBCC" The PBCC (packet binary convolutional coding) physical layer can optionally be used instead of CCK modulation and extends 802.11b to higher data rates (22 Mbps).

SCPI command:

[\[:SOURCE<hw>\]:BB:WLAN:MODE](#) on page 50

Simulation Mode

Selects the simulation mode.

- "Framed" The "framed mode" is the standard operating mode which is also used in the real system. Data packets with the frame structure defined by the standard are generated.

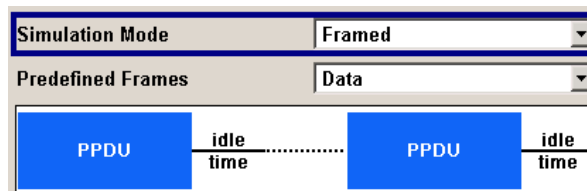

Signals representing a sequence of frames (PLCP protocol data units, referred to as PPDU) and separated by a so-called idle time can be configured in the framed mode. The user data is continued in the consecutive frames, i.e. it is not repeated in each frame. Both the duration of the idle time and the number of frames to be sent can be user-selected.

"Unframed" The "unframed mode" is offered in addition. In this mode, a non-packet-oriented signal without a frame structure is generated with the modulations and data rates defined by 802.11a-g. This mode can be used for simple tests for which only modulation and spectrum of the test signal are of interest.

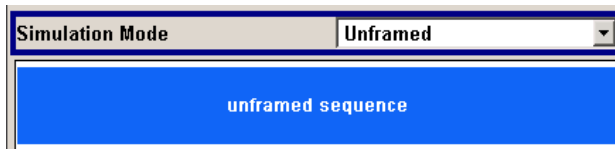

No PLCP preamble and no signal field are generated in the unframed mode. The idle time is also omitted. The data field is identical to that of the framed mode and also contains the service and tail bits. The length limitation stipulated by the standard to the maximum PSDU block length of 4095 bytes in the framed mode does not apply.

Operation is the same as in the framed mode, but only a limited number of setting parameters is available.

SCPI command:

[:SOURCE<hw>] :BB:WLAN:SMODE on page 55

Predefined Frames

(Framed Mode only) Selects the frame type. The selection defines parameters of the MAC layer, e.g. the type and sub-type bit fields of the MAC Header.

"Data" Frames containing useful data.

"RTS" Request to Send.

"CTS" Clear to Send.

"ACK" Acknowledgement.

SCPI command:

[:SOURCE<hw>] :BB:WLAN:FFORMAT on page 49

Sequence Length

Sets the sequence length of the signal in number of frames. A (physical layer) frame consists of a PPDU burst including the subsequent idle time.

SCPI command:

[:SOURCE<hw>] :BB:WLAN:SLENGTH on page 54

Idle time

(based on standard chip rate)

(This feature is available for Framed Mode only).

Sets the idle time, i.e. the time between two PPDU bursts. Idle time is given in μs ; the packets can also be joined to each other directly with idle time 0. Please note that the idle time refers to the chip rate as defined in the standard (11 Mcps for 802.11b/g CCK/PBCC and 20 Mcps for 802.11a/g OFDM). Only at this chip rate does the idle period correspond exactly to the time set. If the chip rate is doubled, for instance, the real idle time is halved.

SCPI command:

[:SOURce<hw>] :BB:WLAN:ITIME on page 50

PPDU Configuration

(This feature is available for Framed Mode only)

Calls the menu for configuration of the PPDU. The menu differs for the physical layer modes.

The menu is described in [chapter 3.2, "PPDU/Sequence Configuration"](#), on page 24.

SCPI command:

n.a.

Sequence Configuration

(This feature is available for Unframed Mode only).

Calls the menu for configuration of the signal in unframed mode modes.

The menu is described in [chapter 3.2, "PPDU/Sequence Configuration"](#), on page 24.

SCPI command:

n.a.

Filter, Clipping

Calls the menu for setting the filter parameters and the clipping. The current setting is displayed next to the button.

The menu is described in Section [chapter 3.5, "Filter/Clipping Settings"](#), on page 35.

SCPI command:

n.a.

Trigger - Marker

(Trigger for R&S SMx and R&S AMU instruments only)

Calls the menu for selecting the trigger source, for configuring the marker signals and for setting the time delay of an external trigger signal (see [chapter 3.6, "Trigger/Marker/Clock Settings"](#), on page 38).

The currently selected trigger source is displayed to the right of the button.

SCPI command:

n.a.

Execute Trigger

(R&S SMx and R&S AMU instruments only)

This feature is available for Trigger Source Internal only.

Executes trigger manually. A manual trigger can be executed only when an internal trigger source and a trigger mode other than "Auto" have been selected.

SCPI command:

[:SOURce<hw>] :BB:WLAN:TRIGger:EXECute on page 64

Clock

(R&S SMx and R&S AMU instruments only)

Calls the menu for selecting the clock source (see [chapter 3.6, "Trigger/Marker/Clock Settings"](#), on page 38).

SCPI command:

n.a.

3.2 PPDU/Sequence Configuration

In **framed mode**, a frame consists of a PPDU (PLCP protocol data unit) and the idle time. The data packet on the physical layer is referred to as PPDU. A PPDU consists of three components; the PLCP preamble, the PLCP header and the PSDU (PLCP service data unit), which contains the actual information data (coming from higher layers).

The PLCP preamble and header are used for synchronization and signaling purposes, and are themselves divided into fields.

The details of the PPDU structure depend on the selected standard or, more precisely, on the physical layer mode (see below).

In **unframed mode**, the signal can be configured via the "PSDU bit rate" and "PSDU modulation" parameters, just as in the Framed mode. However, a preamble or header is not generated; only a continuous PSDU block is generated, the length of which can be varied by using the "Sequence Length" parameter. There is no restriction of the maximum PSDU block length to 4095 bytes as in the Framed mode. Moreover, the data stream can be scrambled prior to the modulation ("Scrambling Mode" parameter).

3.2.1 Standard 802.11a - OFDM

In the upper section of the menu, the parameters of the data part (PSDU) are set. In the middle section, the parameters of the scrambler and interleaver are set. A graph in the lower sections illustrates the structure of the PPDU (framed mode) or the unframed sequence (unframed mode).

- Framed mode:

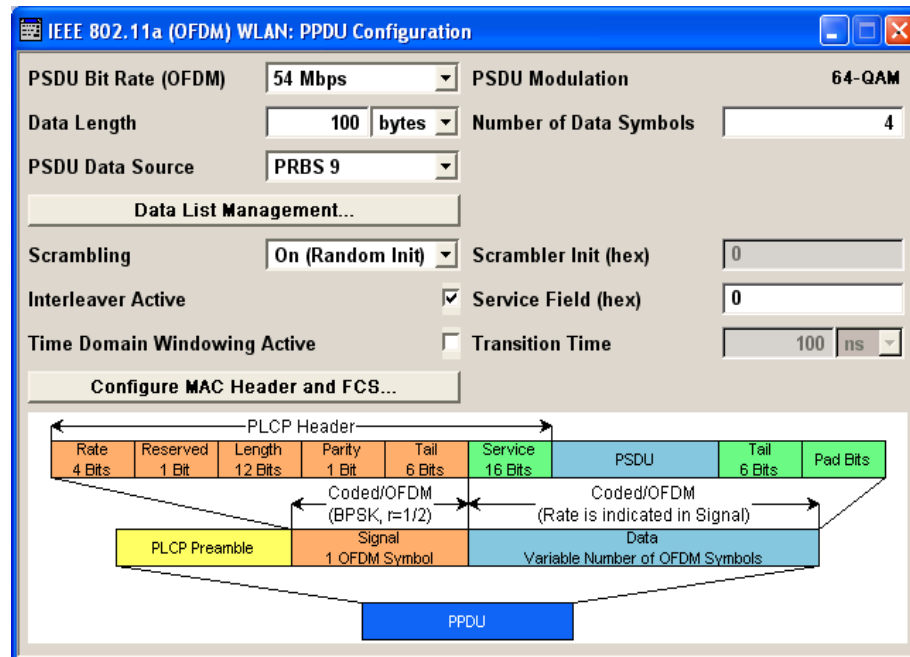

- Unframed mode:

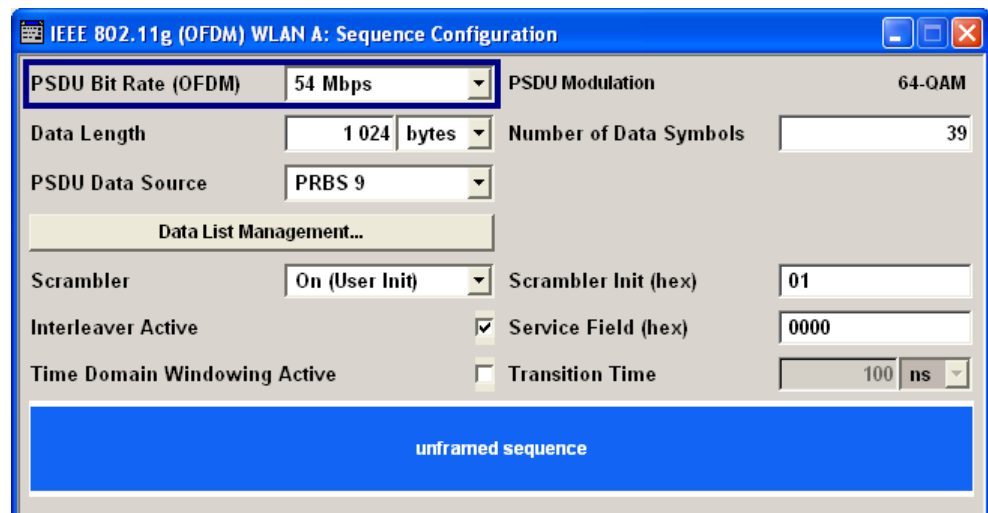

3.2.2 Standard 802.11b/g - CCK - PBCC

In the upper section of the menu, the parameters of the data part (PSDU) are set. In framed mode, a distinction is made between the packet type (or PPDU format) with long or short PLCP (physical layer convergence protocol). A graph in the lower sections illustrates the structure of the PPDU (framed mode) or the unframed sequence (unframed mode).

- Framed Mode:

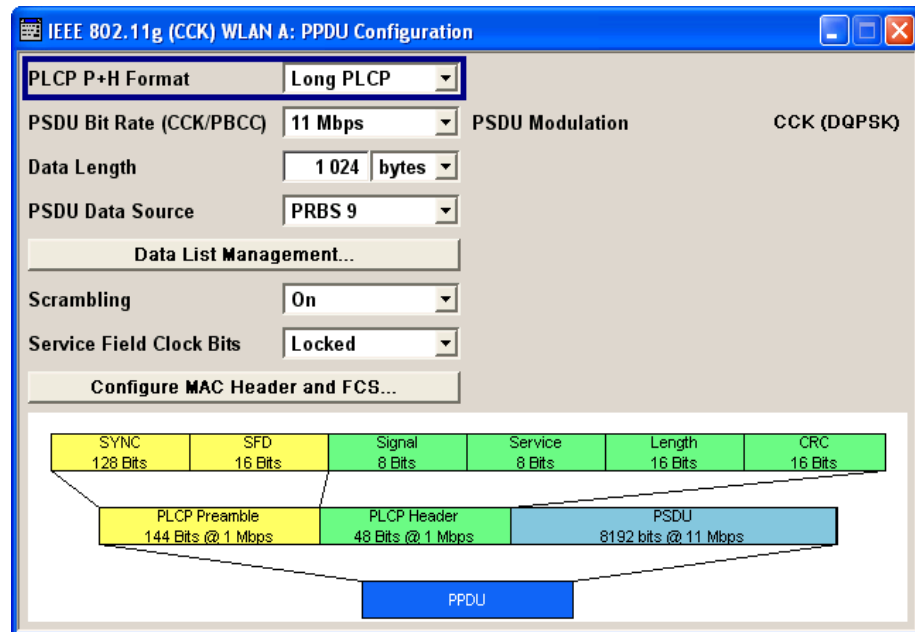

- Unframed Mode:

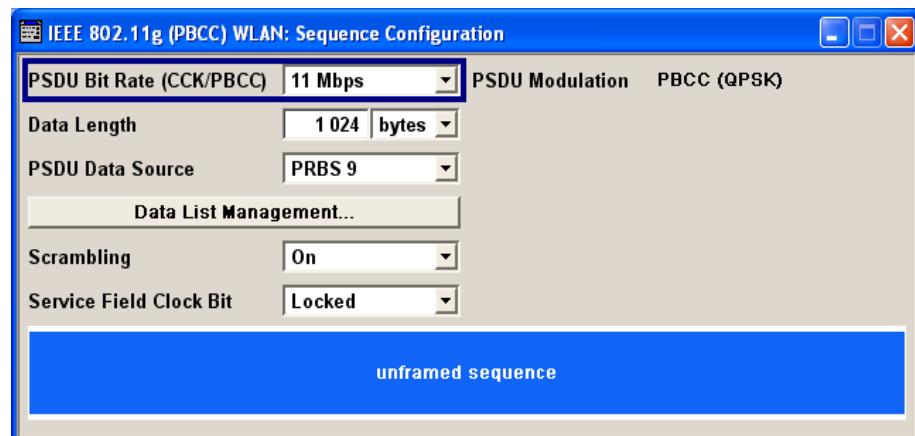

3.2.3 Settings

PLCP P+H Format (CCK,PBCC)

(framed mode)

Selects the packet type (PPDU format) with long or short PLCP (physical layer convergence protocol). Depending on the format selected, the structure, modulation and data rate of the PLCP preamble and header are modified. The format currently set is shown in the graphic display in the lower part of the menu.

See [chapter 2.2, "Physical Layer CCK-PBCC"](#), on page 11 for description of the long and short format.

SCPI command:

[:SOURce<hw>] :BB:WLAN:PLCP:FORMat on page 51

PSDU Bit Rate

Selects the bit rate of the PSDU.

- **OFDM:**
All data rates defined by the standard are supported. The selection of the PSDU bit rate automatically determines the code rate of the convolutional coder and the sub-carrier modulation of the OFDM.

Data rate	Possible modulation mode
6 and 9 Mbps	BPSK
12 and 18 Mbps	QPSK
24 and 36 Mbps	16-QAM
48 and 54 Mbps	64 QAM

- **CCK, PBCC:**
The data rates available are 1 Mbps, 2 Mbps, 5.5 Mbps, 11 Mbps and 22 Mbps. The 1 Mbps data rate is only available if the long PLCP format has been selected (framed mode only). The selection of the data rate also determines the possible modulation modes.

The following table shows the correlation between data rate and modulation.

Data rate	Possible modulation mode
1 Mbps	Barker Sequence (DBPSK) the information data sequence is spread with an 11-chip Barker sequence, chip rate is 11 Mcps
2 Mbps	Barker Sequence (DQPSK) the information data sequence is spread with an 11-chip Barker sequence, chip rate is 11 Mcps
5.5 Mbps	CCK (DQPSK) or PBCC (BPSK)
11 Mbps	CCK (DQPSK) or PBCC (QPSK)
22 Mbps	PBCC (8PSK)

SCPI command:

[\[:SOURCE<hw>\]:BB:WLAN:PSDU:BRATE](#) on page 78

PSDU Modulation

Indicates the modulation type.

"PSDU Modulation (OFDM)" Indicates the modulation type used on the OFDM subcarriers. The modulation mode depends on the selected PSDU bit rate.

"PSDU Modulation (CCK,PBCC)" Indicates the modulation type. The modulation mode depends on the selected PSDU bit rate. The "Physical Layer Mode" parameter in the main menu can be used for switchover between CCK and PBCC.

SCPI command:

[\[:SOURCE<hw>\]:BB:WLAN:PSDU:MODULATION](#) on page 85

Data Length

Sets the data length.

In the framed mode, data field lengths of up to 4095 bytes per frame packet are possible. This corresponds to the maximum data length. If the MAC Layer is activated, the MAC header (up to 30) and the (4) FCS bytes are added.

The unframed mode offers a data length of up to 100000 bytes.

OFDM:

If the data field length is changed, the generator calculates the number of OFDM data symbols as a function of the set PSDU bit rate and displays it in the field "Number of Data Symbols". Data is always rounded up to complete symbols. Free data bits in the last symbol, the so-called pad bits, are filled with 0.

SCPI command:

`[:SOURCE<hw>] :BB:WLAN:PSDU:DLENgth` on page 80

Number of Data Symbols (OFDM)

Sets the number of data symbols per frame packet.

If the number of OFDM data symbols is changed, the generator calculates the data field length as a function of the set PSDU bit rate and displays it at "Data Length".

SCPI command:

`[:SOURCE<hw>] :BB:WLAN:PSDU:SCOunt` on page 85

PSDU Data Source

Selects the data source for the data field.

The following data sources are available:

- | | |
|--------------------------|--|
| "All 0; All 1" | 0 data or 1 data is internally generated. |
| "PRBS; PRBS Type" | PRBS data in accordance with the IUT-T with period lengths between 29-1 and 223-1 are internally generated.
The length is selected in the "PRBS Type" input box. |
| "Pattern" | A user-definable bit pattern with a maximum length of 64 bits is internally generated.
The bit pattern is defined in the "Pattern" input box. |
| "Data List; Select Data" | Data lists will be used.
Data lists can be generated internally in the data editor or externally. Data lists are selected in the "File Select" window, which is called by means of the "Data List" Management button. |



The "File Manager" is used to transmit external data lists to the R&S Signal Generator, and can be called within every File Select window by means of the "File Manager" button.

SCPI command:

`[:SOURCE<hw>] :BB:WLAN:PSDU:DATA` on page 78

`[:SOURCE<hw>] :BB:WLAN:PSDU:DATA:PATtern` on page 79

`[:SOURCE<hw>] :BB:WLAN:PSDU:DATA:DSElect` on page 79

Data List Management...

Calls the "Data List Management" menu. This menu is used to create and edit a data list.

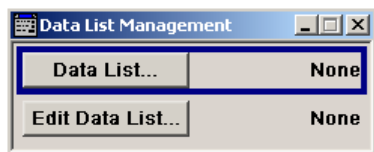

All data lists are stored as files with the predefined file extension `*.dm_iqd`. The file name and the directory they are stored in are user-definable.

The data lists must be selected as a data source from the submenus under the individual function, e.g. in the channel table of the cells.

Note: All data lists are generated and edited by means of the `SOURce:BB:DM` subsystem commands. Files containing data lists usually end with `*.dm_iqd`. The data lists are selected as a data source for a specific function in the individual subsystems of the digital standard.

SCPI command:

`[:SOURce<hw>] :BB:WLAN:PSDU:DATA` on page 78

Scrambler
(OFDM)

Activates/deactivates the scrambler and selects the mode of determining the initialization value.

"OFF"	The scrambler is deactivated.
"Random"	The scrambler is activated. The initialization value of the scrambler is selected at random. Each frame has a different random initialization value. This value is also different in case of successive recalculations with the same setting parameters so that different signals are generated for each calculation.
"User"	The scrambler is activated. The initialization value of the scrambler is set to a fixed value that is entered at "Scrambler Init (hex)". This value is then identical in each generated frame.

SCPI command:

`[:SOURce<hw>] :BB:WLAN:SCRAMbler:MODE` on page 52

Scrambler (CCK,PBCC)

Activates or deactivates the scrambler. Some tests require a test signal without scrambling (e.g. for the RF carrier suppression measurement).

"OFF"	The scrambler is deactivated.
"ON"	The scrambler is activated.
"Preamble Only"	The scrambler is activated. Only the preamble is scrambled.

SCPI command:

`[:SOURce<hw>] :BB:WLAN:SCRAMbler:MODE` on page 52

Service Field Clock Bit (CCK,PBCC)

Sets the Locked Clock Bit in Service Field of the PLCP Header.

Via this flag (bit), the 802.11b/g transmitter indicates whether transmission frequency and symbol rate have been derived from the same oscillator. If this is the case (locked), the bit is set to 1, otherwise (not locked) to 0.

SCPI command:

`[:SOURCE<hw>] :BB:WLAN:PLCP:LCBit:STATE` on page 51

Disable Barker Spreading

(CCK, PBCC)

Activates/deactivates barker spreading (bit rates 1 Mbps or 2 Mbps only).

SCPI command:

`[:SOURCE<hw>] :BB:WLAN:PLCP:LCBit:STATE` on page 51

Scrambler Init (hex) (OFDM)

Enters the initialization value for scrambling mode User. This value is then identical in each generated frame.

SCPI command:

`[:SOURCE<hw>] :BB:WLAN:SCRAMbler:PATTERN` on page 53

Interleaver Active (OFDM)

Activates/deactivates the interleaver.

SCPI command:

`[:SOURCE<hw>] :BB:WLAN:ILEaver:STATE` on page 50

Service field (hex)

Enters the value of the service field. The standard specifies a default value of 0. Other values can be entered in hexadecimal form for test purposes or future extensions.

SCPI command:

`[:SOURCE<hw>] :BB:WLAN:SERVICE[:PATTERN]` on page 53

Time Domain Windowing Active

Activates/deactivates the time domain windowing.

Time domain windowing is a method to influence the spectral characteristics of the signal, which is not stipulated by the standard. However, it does not replace oversampling and subsequent signal filtering.

SCPI command:

`[:SOURCE<hw>] :BB:WLAN:TDWindowing:STATE` on page 56

Transition Time

Sets the transition time when time domain windowing is active.

The transition time defines the overlap range of two OFDM symbols. At a setting of 100 ns, one sample overlaps.

SCPI command:

`[:SOURCE<hw>] :BB:WLAN:TTIME` on page 57

Configure MAC Header and FCS...

Calls the menu for configuration of the MAC Header and FCS.

The menu is described in [chapter 3.3, "MAC Header and FCS Configuration"](#), on page 31.

SCPI command:

n.a.

3.3 MAC Header and FCS Configuration

In the real IEEE 802.11 system, a MAC (medium access control) header is transmitted in the PSDU prior to the actual data section. This header comprises control information of the MAC layer. It is also possible to protect the PSDU by a frame checksum. These two functions can be controlled in the menu.

Protocol Version	Type	Subtype	To DS	From DS	More Frag	Retry	Pwr Mgt	More Data	WEP	Order
00	00	0000	0	0	0	0	0	0	0	0
2 bit (LSBits)	2 bit	4 bit	1 bit	1 bit	1 bit	1 bit	1 bit	1 bit	1 bit	1 bit (MSBit)

FCS (checksum)

Activates/deactivates the calculation of the FCS (frame check sequence). The standard defines a 32-bit (4-byte) check sum to protect the MAC header and the user data (frame body).

SCPI command:

[\[:SOURCE<hw>\]:BB:WLAN:PSDU:MAC:FCSequence:STATE](#) on page 82

MAC Header

Activates/deactivates the generation of the MAC Header for the PSDU. If the MAC header is activated, all MAC header fields are enabled for operation.

The individual fields of the MAC header are described in the following.

All values of the MAC fields (except addresses) are entered in hexadecimal form with LSB in right notation. In the data stream, the values are output standard-conformal with the LSB coming first.

SCPI command:

[\[:SOURCE<hw>\]:BB:WLAN:PSDU:MAC:STATE](#) on page 84

Frame Control

Enters the value of the frame control field.

The Frame control field has a length of 2 bytes (16 bits) and is used to define the protocol version, the frame type, sub type and its function, etc.. As an alternative, the individual bits can be set in the lower part of the graph.

SCPI command:

[:SOURce<hw>] :BB:WLAN:PSDU:MAC:FCONtrol on page 81
[:SOURce<hw>] :BB:WLAN:PSDU:MAC:FCONtrol:PVERsion on page 82
[:SOURce<hw>] :BB:WLAN:PSDU:MAC:FCONtrol:TYPE on page 82
[:SOURce<hw>] :BB:WLAN:PSDU:MAC:FCONtrol:SUBType on page 82
[:SOURce<hw>] :BB:WLAN:PSDU:MAC:FCONtrol:TDS on page 82
[:SOURce<hw>] :BB:WLAN:PSDU:MAC:FCONtrol:FDS on page 81
[:SOURce<hw>] :BB:WLAN:PSDU:MAC:FCONtrol:MFRagments on page 82
[:SOURce<hw>] :BB:WLAN:PSDU:MAC:FCONtrol:RETRy on page 82
[:SOURce<hw>] :BB:WLAN:PSDU:MAC:FCONtrol:PMANagement on page 82
[:SOURce<hw>] :BB:WLAN:PSDU:MAC:FCONtrol:MDATa on page 82
[:SOURce<hw>] :BB:WLAN:PSDU:MAC:FCONtrol:WEP on page 82
[:SOURce<hw>] :BB:WLAN:PSDU:MAC:FCONtrol:ORDer on page 82

Duration Id

Enters the value of the duration Id field.

Depending on the frame type, the 2-byte field Duration/ID is used to transmit the association identity of the station transmitting the frame or it indicates the duration assigned to the frame type.

SCPI command:

[:SOURce<hw>] :BB:WLAN:PSDU:MAC:DID on page 81

MAC Address

Enters the value of the address fields 1 ... 4.

The MAC header may contain up to four address fields, but not all of them must be available. Each of the 4 address fields can be activated or deactivated. The fields are used for transmitting the basic service set identifier, the destination address, the source address, the receiver address and the transmitter address. Each address is 6 bytes (48 bit) long. The addresses can be entered in hexadecimal form in the entry field of each address field. The least significant byte (LSB) is in left notation.

SCPI command:

[:SOURce<hw>] :BB:WLAN:PSDU:MAC:ADDRess<ch> on page 80

Sequence Control

Activates/deactivates the sequence control field.

The sequence control field has a length of 2 bytes and is divided in two parts, the fragment number (4 bits) and the sequence number (12 bits) field. A long user data stream to be transmitted is first split up into MSDUs (MAC service data units) which can either be transmitted as PSDU frames or further divided into fragments. The sequence number and the fragment number are then used to number the individual subpackets of the user data stream to be transmitted. Thus, all PSDUs are assigned a consecutive number. This allows the receiver to arrange the data packets in the correct order, to determine whether an incorrectly transmitted packet was retransmitted and to find out whether packets are missing.

If the receiver can detect a packet without an error and does not request a retransmission, the sequence number is incremented by 1 for each packet (the field is reset to 0 at the latest after a count of 4095). The fragment number field is incremented by 1 when another fragment of the current MPDU is transmitted. The start count for the transmission (normally 0) and the number of packets required to increment the corresponding counter can be defined for both numbers. This is done with the parameters "Start Number" and "Incremented every ... packet(s)" (see below).

Example:

An error-free transmission of 50 packets (no packet retransmission) is to be simulated. The sequence number should be incremented by 1 for each packet. Since no packet is fragmented, the fragment counter can always remain at 0. In this case the following values have to be set:

Address 2 (hex)	Address 3 (hex)	Sequence Control		Address 4 (hex)	Frame Body	FCS
Enable <input type="checkbox"/>	Enable <input checked="" type="checkbox"/>	Enable <input checked="" type="checkbox"/>		Enable <input checked="" type="checkbox"/>		
000 0000 0000	000 AC77 6ED2	Frag	Sequ	002 3ED3 4290	0 - 4095	
6 bytes	6 bytes	4 bit	12 bit	6 bytes	bytes	4 byte
Start Number (hex) 0		Start Number (hex) 000				
Incremented Every 4 096 packet(s)		Incremented Every 1 packet(s)				

If it is to be simulated that some packets are received incorrectly or if the response of the receiver should be tested when the same packet arrives several times, the number of packets required to increment the sequence number can be set to 2, for example. Each packet will then automatically be sent twice (with identical data).

SCPI command:

`[:SOURce<hw>] :BB:WLAN:PSDU:MAC:SCONtrol:STATe` on page 84

`[:SOURce<hw>] :BB:WLAN:PSDU:MAC:SCONtrol:FRAGment:START` on page 83

`[:SOURce<hw>] :BB:WLAN:PSDU:MAC:SCONtrol:SEQUence:START` on page 84

`[:SOURce<hw>] :BB:WLAN:PSDU:MAC:SCONtrol:FRAGment:INCRement`
on page 83

`[:SOURce<hw>] :BB:WLAN:PSDU:MAC:SCONtrol:SEQUence:INCRement`
on page 83

Start Number

Sets the start number of the fragment bits or the sequence bits of the sequence control.

SCPI command:

`[:SOURCE<hw>] :BB:WLAN:PSDU:MAC:SCONTrol:FRAGment:START` on page 83

`[:SOURCE<hw>] :BB:WLAN:PSDU:MAC:SCONTrol:SEQuence:START` on page 84

Increment Every

Defines the number of packets required to increment the counter of the fragment bits or the sequence bits of the sequence control.

SCPI command:

`[:SOURCE<hw>] :BB:WLAN:PSDU:MAC:SCONTrol:FRAGment:INCReMENT`
on page 83

`[:SOURCE<hw>] :BB:WLAN:PSDU:MAC:SCONTrol:SEQuence:INCReMENT`
on page 83

Frame Body

Indicates the length of the user data (frame body).

SCPI command:

n.a.

FCS

Indicates the length of the check sum.

SCPI command:

n.a.

3.4 PPDU Graph

The frame graph in the lower part of the menu indicates the configuration of the PPDU.

The frame structure for the different physical layer modes is described in [chapter 2.2, "Physical Layer CCK-PBCC"](#), on page 11.

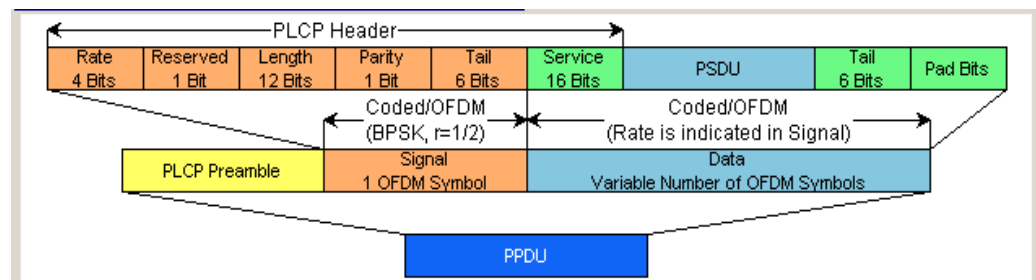

Fig. 3-1: Physical layer Mode OFDM

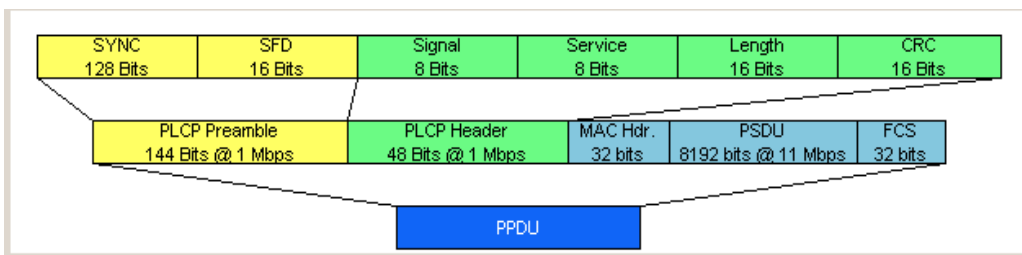
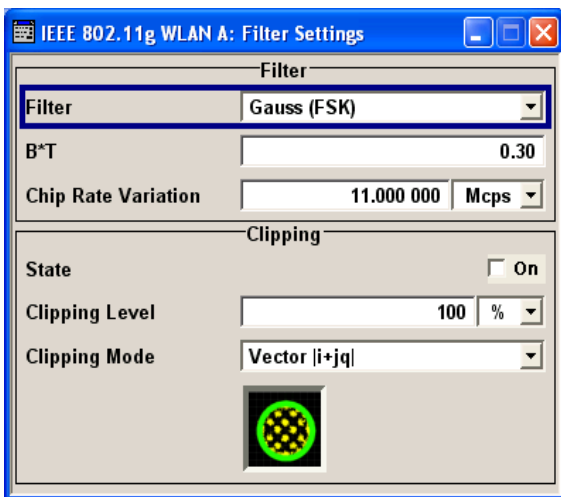

Fig. 3-2: Physical layer Mode CCK, Long PLCP

3.5 Filter/Clipping Settings

To access this dialog, select "Main Menu > Filter/Clipping".

The baseband filter, sample rate variation and clipping are defined in this menu.



3.5.1 Filter Settings

Filter

Sets the baseband filter.

This opens a selection window containing all the filters available to the instrument.

In 802.11a/g OFDM mode, a cosine filter with roll-off factor 0.1 is used by default to achieve the spectrum masks requirement.

In 802.11b/g CCK/PBCC mode, a gauss (FSK) filter with B*T 0.5 is used by default to achieve the spectrum masks requirement.

SCPI command:

[:SOURce<hw>] :BB:WLAN:FILTer:TYPE on page 59

Roll Off Factor / BxT

Sets the filter parameter.

The filter parameter offered ("Roll Off Factor" or "BxT") depends on the currently selected filter type. This parameter is preset to the default for each of the predefined filters.

SCPI command:

[\[:SOURce<hw>\]:BB:WLAN:FILTer:PARAmeter:APCO25](#) on page 60

[\[:SOURce<hw>\]:BB:WLAN:FILTer:PARAmeter:COsine](#) on page 60

[\[:SOURce<hw>\]:BB:WLAN:FILTer:PARAmeter:GAUSs](#) on page 61

[\[:SOURce<hw>\]:BB:WLAN:FILTer:PARAmeter:RCOSine](#) on page 62

[\[:SOURce<hw>\]:BB:WLAN:FILTer:PARAmeter:SPHase](#) on page 62

[\[:SOURce<hw>\]:BB:WLAN:FILTer:PARAmeter:PGAuss](#) on page 62

Cut Off Frequency Factor

(available for filter parameter Lowpass only)

Sets the value for the cut off frequency factor. The cut off frequency of the filter can be adjusted to reach spectrum mask requirements.

SCPI command:

[\[:SOURce<hw>\]:BB:WLAN:FILTer:PARAmeter:LPASs](#) on page 61

[\[:SOURce<hw>\]:BB:WLAN:FILTer:PARAmeter:LPASSEVM](#) on page 61

Chip Rate Variation

Enters the chip rate. For each physical layer mode an own parameter is defined. Which parameter is affected depends on the currently selected mode.

The chip rate entry changes the output clock and the modulation bandwidth, as well as the synchronization signals that are output. It does not affect the calculated chip sequence.

SCPI command:

[\[:SOURce<hw>\]:BB:WLAN:CRATe:VARIation](#) on page 62

Impulse Length

(For WinIQSIM2 only)

Displays the number of filter tabs. If the check box is activated, the most sensible parameter values are selected. The value depends on the coherence check. If the check box is deactivated, the values can be changed manually.

SCPI command:

[\[:SOURce<hw>\]:BB:WLAN:FILTer:ILENgtH:AUTO](#) on page 59

[\[:SOURce<hw>\]:BB:WLAN:FILTer:ILENgtH](#) on page 59

Oversampling

(For WinIQSIM2 only)

Determines the upsampling factor. If the check box is activated, the most sensible parameter values are selected. The value depends on the coherence check. If the check box is deactivated, the values can be changed manually.

SCPI command:

[\[:SOURce<hw>\]:BB:WLAN:FILTer:OSAMpling:AUTO](#) on page 60

[\[:SOURce<hw>\]:BB:WLAN:FILTer:OSAMpling](#) on page 60

3.5.2 Clipping Settings

The settings for clipping are collected in the "Clipping" section.

Clipping State

Switches baseband clipping on and off.

Baseband clipping is a very simple and effective way of reducing the crest factor of the WLAN signal.

WLAN signals may have high crest factors particularly in the 802.11a/g OFDM mode. High crest factors entail two basic problems:

- The nonlinearity of the power amplifier (compression) causes intermodulation which expands the spectrum (spectral regrowth).
- Since the level in the D/A converter is relative to the maximum value, the average value is converted with a relatively low resolution. This results in a high quantization noise.

Both effects increase the adjacent-channel power.

With baseband clipping, all the levels are limited to a settable value (Clipping Level). This level is specified as a percentage of the highest peak value. Since clipping is done prior to filtering, the procedure does not influence the spectrum. The EVM however increases. Since clipping the signal not only changes the peak value but also the average value, the effect on the crest factor is unpredictable.

SCPI command:

[\[:SOURCE<hw>\]:BB:WLAN:CLIPPING:STATE](#) on page 58

Clipping Level

Sets the limit for clipping.

This value indicates at what point the signal is clipped. It is specified as a percentage, relative to the highest level. 100% indicates that clipping does not take place.

SCPI command:

[\[:SOURCE<hw>\]:BB:WLAN:CLIPPING:LEVEL](#) on page 58

Clipping Mode

Selects the clipping method. A graphic illustration of the way in which these two methods work is given in the menu.

"Vector $|i + jq|$ " The limit is related to the amplitude $|i + jq|$. The I and Q components are mapped together, the angle is retained.



"Scalar | i | + | q The limit is related to the absolute maximum of all the I and Q values | i | + | q | ."



The I and Q components are mapped separately, the angle changes.

SCPI command:

[\[:SOURce<hw>\]:BB:WLAN:CLIPping:MODE](#) on page 58

3.6 Trigger/Marker/Clock Settings



The trigger, clock, and marker delay functions are available for R&S SMx and R&S AMU instruments only.

To access this dialog, select "Main Menu > Trigger/Marker".

The "Trigger In" section is where the trigger for the signal is set. Various parameters will be provided for the settings, depending on which trigger source - internal or external - is selected. The current status of signal generation ("Running" or "Stopped") is indicated for all trigger modes.

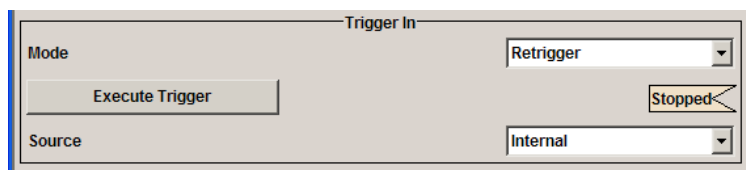

The "Marker Mode" section is where the marker signals at the MARKER output connectors are configured.

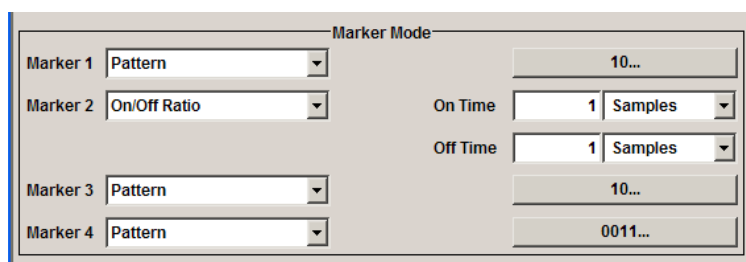

The "Marker Delay" section is where a marker signal delay can be defined, either without restriction or restricted to the dynamic section, i.e., the section in which it is possible to make settings without restarting signal and marker generation.

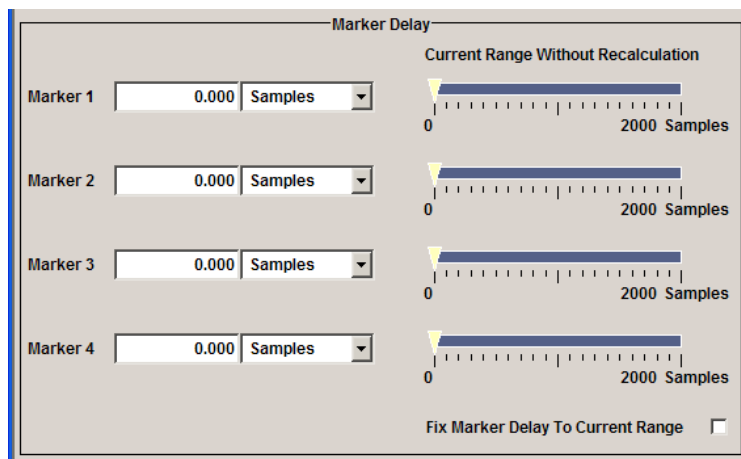

The "Clock Settings" section is where the clock source is selected and - in the case of an external source - the clock type.

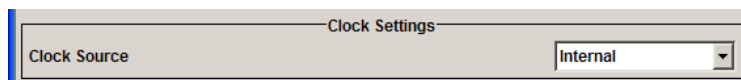

The buttons in the last section lead to submenu for general trigger, clock and mapping settings.



3.6.1 Trigger In



The trigger functions are available for R&S SMx and R&S AMU instruments only.

The "Trigger In" section is where the trigger for the signal is set. Various parameters will be provided for the settings, depending on which trigger source - internal or external - is selected. The current status of signal generation ("Running" or "Stopped") is indicated for all trigger modes.

Trigger Mode

Selects trigger mode.

The trigger mode determines the effect of a trigger on the signal generation.

- "Auto" The signal is generated continuously.
- "Retrigger" The signal is generated continuously. A trigger event (internal or external) causes a restart.

- "Armed_Auto" The signal is generated only when a trigger event occurs. Then the signal is generated continuously.
Button "Arm" stops signal generation. A subsequent trigger event (internal with "Execute Trigger" or external) causes a restart.
- "Armed_Retrigger" The signal is generated only when a trigger event occurs. Then the signal is generated continuously. Every subsequent trigger event causes a restart.
Button "Arm" stops signal generation. A subsequent trigger event (internal with "Execute Trigger" or external) causes a restart.
- "Single" The signal is generated only when a trigger event occurs. Then the signal is generated once to the length specified at "Signal Duration".
Every subsequent trigger event (internal with "Execute Trigger" or external) causes a restart.

SCPI command:

[\[:SOURCE<hw>\]:BB:WLAN\[:TRIGGER\]:SEQUENCE](#) on page 69

Signal Duration

Defines the length of the signal sequence to be output in the "Single" trigger mode. The input is to be expressed in chips.

It is possible to output deliberately just part of the signal, an exact sequence of the signal, or a defined number of repetitions of the signal.

SCPI command:

[\[:SOURCE<hw>\]:BB:WLAN:TRIGGER:SLLENGTH](#) on page 66

[\[:SOURCE<hw>\]:BB:WLAN:TRIGGER:SLUNIT](#) on page 67

Running/Stopped

Displays the status of signal generation for all trigger modes. This display appears only when signal generation is enabled ("State" On).

- "Running" The modulation signal is generated; a trigger was (internally or externally) initiated in triggered mode.
If "Armed_Auto" and "Armed_Retrigger" have been selected, generation of signals can be stopped with the "Arm" button. A new trigger (internally with "Execute Trigger" or externally) causes a restart.
- "Stopped" The signal is not generated, and the instrument waits for a trigger event (internal or external).

SCPI command:

[\[:SOURCE<hw>\]:BB:WLAN:TRIGGER:RMODE](#) on page 66

Arm

Stops signal generation. This button appears only with "Running" signal generation in the "Armed_Auto" and "Armed_Retrigger" trigger modes.

Signal generation can be restarted by a new trigger (internally with "Execute Trigger" or externally).

SCPI command:

[\[:SOURCE<hw>\]:BB:WLAN:TRIGGER:ARM:EXECUTE](#) on page 63

Execute Trigger

(R&S SMx and R&S AMU instruments only)

This feature is available for Trigger Source Internal only.

Executes trigger manually. A manual trigger can be executed only when an internal trigger source and a trigger mode other than "Auto" have been selected.

SCPI command:

`[:SOURce<hw>] :BB:WLAN:TRIGger:EXECute` on page 64

Trigger Source

Selects trigger source. This setting is effective only when a trigger mode other than "Auto" has been selected.

"Internal" The trigger event is executed by "Execute Trigger".

"Internal (Base- (two-path instruments only)

band A/B)" The trigger event is executed by the trigger signal from the second path

"External The trigger event is executed with the aid of the active edge of an external (TRIGGER 1 /

2)" The trigger signal is supplied via the TRIGGER connector.

The polarity, the trigger threshold and the input impedance of the TRIGGER input can be set in the "Global Trigger/Clock Settings" dialog.

SCPI command:

`[:SOURce<hw>] :BB:WLAN:TRIGger:SOURce` on page 67

Sync. Output to External Trigger

(enabled for Trigger Source External)

Enables/disables output of the signal synchronous to the external trigger event.

For R&S SMBV instruments:

For or two or more R&S SMBVs configured to work in a master-slave mode for synchronous signal generation, configure this parameter depending on the provided system trigger event and the properties of the output signal. See the table below for an overview of the required settings.

Table 3-1: Typical Applications

System Trigger	Application	"Sync. Output to External Trigger"
Common External Trigger event for the master and the slave instruments	All instruments are synchronous to the external trigger event	ON
	All instruments are synchronous among themselves but starting the signal from first symbol is more important than synchronicity with external trigger event	OFF
Internal trigger signal of the master R&S SMBV for the slave instruments	All instruments are synchronous among themselves	OFF

"On"

Corresponds to the default state of this parameter.

The signal calculation starts simultaneously with the external trigger event but because of the instrument's processing time the first samples are cut off and no signal is outputted. After elapsing of the internal processing time, the output signal is synchronous to the trigger event.

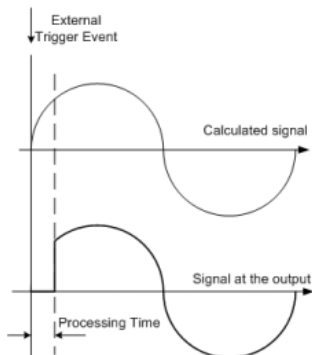

"Off"

The signal output begins after elapsing of the processing time and starts with sample 0, i.e. the complete signal is outputted.

This mode is recommended for triggering of short signal sequences with signal duration comparable with the processing time of the instrument.

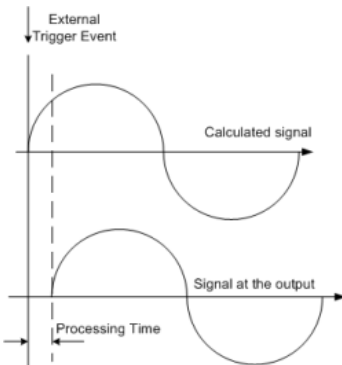

SCPI command:

```
[ :SOURce<hw> ] :BB:WLAN:TRIGger:EXTeRnal:SYNChronize:OUTPut
on page 64
```

Trigger Delay

Sets the trigger signal delay in samples on external triggering or on internal triggering via the second path.

Sets the trigger signal delay in samples on external triggering.

This enables the R&S Signal Generator to be synchronized with the device under test or other external devices.

For two-path instruments, the delay can be set separately for each of the two paths.

SCPI command:

```
[ :SOURce<hw> ] :BB:WLAN:TRIGger [ :EXTeRnal<ch> ] :DELay on page 68
[ :SOURce<hw> ] :BB:WLAN:TRIGger:OBASeband:INHibit on page 65
```

Trigger Inhibit

Sets the duration for inhibiting a new trigger event subsequent to triggering. The input is to be expressed in samples.

In the "Retrigger" mode, every trigger signal causes signal generation to restart. This restart is inhibited for the specified number of samples.

This parameter is only available on external triggering or on internal triggering via the second path.

For two-path instruments, the trigger inhibit can be set separately for each of the two paths.

SCPI command:

[\[:SOURCE<hw>\]:BB:WLAN:TRIGGER\[:EXTERNAL<ch>\]:INHIBIT](#) on page 68

[\[:SOURCE<hw>\]:BB:WLAN:TRIGGER:OBASBAND:INHIBIT](#) on page 65

3.6.2 Marker Mode

The marker output signal for synchronizing external instruments is configured in the marker settings section "Marker Mode".

The R&S SMBV supports only two markers.

Marker Mode

Selects a marker signal for the associated "MARKER" output.

- | | |
|----------------|---|
| "Restart" | A marker signal is generated at the start of each signal sequence (period = selected number of frames). |
| "Frame Start" | A marker signal is generated at the start of each frame (period = PPDU + idle time). |
| "Frame Active" | A marker signal is generated at the start of every active part of the frame. The active data transfer part (PPDU) of a frame period is marked with high, the inactive part (idle time) with low. This marker can be used to decrease the carrier leakage during inactive signal parts by feeding it into the pulse modulator. |
| "Pulse" | A regular marker signal is generated. The pulse frequency is defined by entering a divider. The frequency is derived by dividing the sample rate by the divider. The input box for the divider opens when "Pulse" is selected, and the resulting pulse frequency is displayed below it. |

SCPI command:

[\[:SOURCE<hw>\]:BB:WLAN:TRIGGER:OUTPUT<ch>:PULSE:DIVIDER](#) on page 73

[\[:SOURCE<hw>\]:BB:WLAN:TRIGGER:OUTPUT<ch>:PULSE:FREQUENCY](#)
on page 74

- | | |
|------------|---|
| "Pattern " | A marker signal that is defined by a bit pattern is generated. The pattern has a maximum length of 64 bits and is defined in an input field which opens when pattern is selected. |
|------------|---|

SCPI command:

[\[:SOURCE<hw>\]:BB:WLAN:TRIGGER:OUTPUT<ch>:PATTERN](#) on page 73

"ON/OFF
Period"

A regular marker signal that is defined by an ON/OFF ratio is generated. A period lasts one ON and OFF cycle.

The "ON Time" and "OFF Time" are each expressed as a number of samples and are set in an input field which opens when ON/OFF ratio is selected.

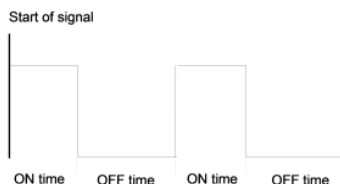

SCPI command:

[\[:SOURce<hw>\]:BB:WLAN:TRIGger:OUTPut<ch>:ONTime](#) on page 73

[\[:SOURce<hw>\]:BB:WLAN:TRIGger:OUTPut<ch>:OFFTime](#) on page 73

SCPI command:

[\[:SOURce<hw>\]:BB:WLAN:TRIGger:OUTPut<ch>:MODE](#) on page 72

3.6.3 Marker Delay

The delay of the signals on the MARKER outputs is set in the "Marker Delay" section.



The marker delay functions are available for R&S SMx and R&S AMU instruments only.

The R&S SMBV supports only two markers.

Marker x Delay

Enters the delay between the marker signal at the marker outputs and the start of the frame or slot.

The input is expressed as a number of symbols/samples. If the setting "Fix marker delay to dynamic range" is enabled, the setting range is restricted to the dynamic range. In this range the delay of the marker signals can be set without restarting the marker and signal.

SCPI command:

[\[:SOURce<hw>\]:BB:WLAN:TRIGger:OUTPut<ch>:DELaY](#) on page 70

Current Range without Recalculation

Displays the dynamic range within which the delay of the marker signals can be set without restarting the marker and signal.

The delay can be defined by moving the setting mark.

SCPI command:

[\[:SOURce<hw>\]:BB:WLAN:TRIGger:OUTPut<ch>:DELaY:MINimum](#) on page 71

[\[:SOURce<hw>\]:BB:WLAN:TRIGger:OUTPut<ch>:DELaY:MAXimum](#) on page 71

Fix marker delay to current range

Restricts the marker delay setting range to the dynamic range. In this range the delay can be set without restarting the marker and signal.

SCPI command:

`[:SOURce<hw>] :BB:WLAN:TRIGger:OUTPut:DElay:FIXed` on page 70

3.6.4 Clock Settings

The Clock Settings is used to set the clock source and a delay if required.



The clock functions are available for R&S SMx and R&S AMU instruments only.

Sync. Mode

(for R&S SMBV only)

Selects the synchronization mode.

This parameter is used to enable generation of very precise synchronous signal of several connected R&S SMBVs.

Note: If several instruments are connected, the connecting cables from the master instrument to the slave one and between each two consecutive slave instruments must have the same length and type.

Avoid unnecessary cable length and branching points.

"None" The instrument is working in stand-alone mode.

"Sync. Master" The instrument provides all connected instrument with its synchronisation (including the trigger signal) and reference clock signal.

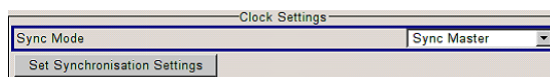

"Sync. Slave" The instrument receives the synchronisation and reference clock signal from another instrument working in a master mode.

SCPI command:

`[:SOURce<hw>] :BB:WLAN:CLOCK:SYNChronization:MODE` on page 76

Set Synchronization Settings

(for R&S SMBV only)

Performs automatically adjustment of the instrument's settings required for the synchronization mode, selected with the parameter "Synchronization Mode".

SCPI command:

`[:SOURce<hw>] :BB:WLAN:CLOCK:SYNChronization:EXECute` on page 76

Clock Source

Selects the clock source.

"Internal" The internal clock reference is used to generate the symbol clock.

"External" The external clock reference is fed in as the symbol clock or multiple thereof via the CLOCK connector.
 The symbol rate must be correctly set to an accuracy of +/-2 % (see data sheet).
 The polarity of the clock input can be changed with the aid of "Global Trigger/Clock Settings".
 In the case of two-path instruments this selection applies to path A.

SCPI command:

`[:SOURce<hw>] :BB:WLAN:CLOCK:SOURce` on page 75

Clock Mode

(Clock source External only)

Enters the type of externally supplied clock.

"Chip" A chip clock is supplied via the CLOCK connector.

"Multiple" A multiple of the chip clock is supplied via the CLOCK connector; the chip clock is derived internally from this.
 The Multiplier window provided allows the multiplication factor to be entered.

SCPI command:

`[:SOURce<hw>] :BB:WLAN:CLOCK:MODE` on page 74

Chip Clock Multiplier

Enters the multiplication factor for clock type Multiple.

SCPI command:

`[:SOURce<hw>] :BB:WLAN:CLOCK:MULTIplier` on page 75

Measured External Clock

Indicates the measured frequency of the external clock signal. This enables the user to permanently monitor the frequency of the externally introduced clock.

This information is displayed only if the external clock source has been selected.

SCPI command:

`CLOC:INP:FREQ?`

3.6.5 Global Settings

The buttons in this section lead to submenu for general trigger, clock and mapping settings.

This settings are available for R&S SMx and R&S AMU instruments only.

Global Trigger/Clock Settings

Calls the "Global Trigger/Clock/Input Settings" dialog.

This dialog is used among other things for setting the trigger threshold, the input impedance and the polarity of the clock and trigger inputs.

In the case of two-path instruments, these settings are valid for both paths.

The parameters in this menu affect all digital modulations and standards, and are described in chapter "Global Trigger/Clock/Input Settings" in the Operating Manual.

User Marker / AUX I/O Settings

Calls the "User Marker AUX I/O Settings" menu, used used to map the connector on the rear of the instruments.

See also "User Marker / AUX I/O Settings" in the Operating Manual.

4 Remote-Control Commands

This subsystem contains commands for the primary and general settings of the IEEE 802.11a-g WLAN standard. These settings concern activation and deactivation of the standard, setting the transmission direction, filter, clock, trigger and clipping settings, defining the frame duration and the sequence length, as well as the preset setting.

The commands for defining the frame configuration for physical layer modes OFDM and CCK/PBCC are described in the next section. The commands are divided up in this way to make the comprehensive `SOURCE:BB:WLAN` subsystem clearer.

SOURCE<hw>

For one-path instruments, the keyword `SOURCE` is optional and can be omitted.

The numeric suffix to `SOURCE` distinguishes between signal generation for path A and path B in the case of two-path instruments:

- `SOURCE[1]` = path A
The keyword `SOURCE` is optional and can be omitted
- `SOURCE2` = path B
The keyword `SOURCE` is mandatory, i.e. the command must contain the keyword with suffix 2.

OUTPUT<ch>

The numeric suffix to `OUTPUT` distinguishes between the available markers.

Only two markers are available for the R&S SMBV, i.e. the allowed values for the suffix are 1 or 2.

Placeholder <root>

For commands that read out or save files in the default directory, the default directory is set using command `MMEM:CDIRECTORY`. The examples in this description use the placeholder `<root>` in the syntax of the command.

- `D:\` - for selecting the internal hard disk of Windows instruments
- `E:\` - for selecting the memory stick which is inserted at the USB interface of Windows instruments
- `/var/<instrument>` - for selecting the internal flash card of Linux instrument, where `<instrument>` is the instrument name, e.g. `smbv`.
- `/usb` - for selecting the memory stick which is inserted at the USB interface of Linux instrument.

4.1 General Commands

<code>[SOURCE<hw>]:BB:WLAN:FFORMAT</code>	49
<code>[SOURCE<hw>]:BB:WLAN:ILEAVER:STATE</code>	50
<code>[SOURCE<hw>]:BB:WLAN:ITIME</code>	50
<code>[SOURCE<hw>]:BB:WLAN:MODE</code>	50

<code>[:SOURCE<hw>]:BB:WLAN:PLCP:FORMat</code>	51
<code>[:SOURCE<hw>]:BB:WLAN:PLCP:LCBit:STATe</code>	51
<code>[:SOURCE<hw>]:BB:WLAN:PRESet</code>	52
<code>[:SOURCE<hw>]:BB:WLAN:SCRambler:MODE</code>	52
<code>[:SOURCE<hw>]:BB:WLAN:SCRambler:PATtern</code>	53
<code>[:SOURCE<hw>]:BB:WLAN:SERVice[:PATtern]</code>	53
<code>[:SOURCE<hw>]:BB:WLAN:SETTing:CATalog</code>	53
<code>[:SOURCE<hw>]:BB:WLAN:SETTing:DELete</code>	54
<code>[:SOURCE<hw>]:BB:WLAN:SETTing:LOAD</code>	54
<code>[:SOURCE<hw>]:BB:WLAN:SETTing:STORe</code>	54
<code>[:SOURCE<hw>]:BB:WLAN:SLenGth</code>	54
<code>[:SOURCE<hw>]:BB:WLAN:SMODE</code>	55
<code>[:SOURCE<hw>]:BB:WLAN:STANdard</code>	55
<code>[:SOURCE<hw>]:BB:WLAN:STATe</code>	56
<code>[:SOURCE<hw>]:BB:WLAN:TDWindowing:STATe</code>	56
<code>[:SOURCE<hw>]:BB:WLAN:TTIME</code>	57

`[:SOURCE<hw>]:BB:WLAN:FFORmat <Fformat>`

The command selects the frame type. The selection defines parameters of the MAC layer, e.g. the values of the MAC Header bit fields. The command is only valid in framed mode (`SOURCE:BB:WLAN:SMODE FRAMed`).

The selection defines parameters of the MAC layer, e.g. the values of the MAC Header bit fields

Parameters:

<code><Fformat></code>	<code>DATA RTS CTS ACK USER</code>
	DATA
	Predefined settings for data transmission.
	RTS
	Predefined settings for Request to Send.
	CTS
	Predefined settings for Clear to Send.
	ACK
	Predefined settings for Acknowledgement.
	USER
	User defined settings (response for query only)
	*RST: DATA

Example:

```
BB:WLAN:SMODE FRAM
selects framed mode.
BB:WLAN:FFOR RTS
selects frame type RTS.
```

[:SOURCE<hw>]:BB:WLAN:ILEAVER:STATE <State>

The command activates/deactivates the interleaver. This command is only available in physical layer mode OFDM (SOURCE:BB:WLAN:MODE OFDM).

Parameters:

<State> 0|1|OFF|ON
 *RST: ON

Example:

```
BB:WLAN:STAN STAN80211g
selects standard 802.11g.
BB:WLAN:MODE OFDM
selects physical layer mode OFDM.
BB:WLAN:ILE ON
activates the interleaver.
```

[:SOURCE<hw>]:BB:WLAN:ITIME <ITime>

The command selects the Physical Layer Mode.

Parameters:

<ITime> float

OFDM

The OFDM (orthogonal frequency division multiplexing) physical layer supports a frame-based transmission. The OFDM (orthogonal frequency division multiplexing) signal is divided into 52 carriers. The symbol rate of the modulation on the individual carriers is 250 kHz. A user data rate of up to 54 Mbps at a channel bandwidth of 20 MHz can be obtained by combining 48 useful carriers for data transmission (4 carriers are used for pilots) and using 64QAM for subcarrier modulation. With OFDM, the individual carriers are superimposed mutually orthogonal, which, in the ideal case, does not cause any intercarrier interference (ICI).

CCK

The CCK (complementary code keying) physical layer mode is used for the 5.5 Mbps and 11 Mbps data rates.

PBCC

The PBCC (packet binary convolutional coding) physical layer can optionally be used instead of CCK modulation.

Range: 0 to 1

*RST: OFDM

Example:

```
BB:WLAN:MODE OFDM
selects physical layer mode OFDM.
```

[:SOURCE<hw>]:BB:WLAN:MODE <Mode>

The command selects the Physical Layer Mode.

Parameters:

<Mode> CCK|PBCC|OFDM

OFDM

The OFDM (orthogonal frequency division multiplexing) physical layer supports a frame-based transmission. The OFDM (orthogonal frequency division multiplexing) signal is divided into 52 carriers. The symbol rate of the modulation on the individual carriers is 250 kHz. A user data rate of up to 54 Mbps at a channel bandwidth of 20 MHz can be obtained by combining 48 useful carriers for data transmission (4 carriers are used for pilots) and using 64QAM for subcarrier modulation. With OFDM, the individual carriers are superimposed mutually orthogonal, which, in the ideal case, does not cause any intercarrier interference (ICI).

CCK

The CCK (complementary code keying) physical layer mode is used for the 5.5 Mbps and 11 Mbps data rates.

PBCC

The PBCC (packet binary convolutional coding) physical layer can optionally be used instead of CCK modulation.

*RST: CCK

Example:

```
BB:WLAN:MODE OFDM
selects physical layer mode OFDM.
```

[[:SOURce<hw>]:BB:WLAN:PLCP:FORMat <Format>

The command selects the packet type (PPDU format) with long or short PLCP (physical layer convergence protocol) (framed mode only). Depending on the format selected, the structure, modulation and data rate of the PLCP preamble and header are modified. The command is only available in framed mode (*SOURce:BB:WLAN:SMODE FRAMed*) and for physical layer mode CCK and PBCC (*SOURce:BB:WLAN:MODE CCK|PBCC*).

Parameters:

<Format> LONG|SHORT

*RST: LONG

Example:

```
BB:WLAN:PLCP:FORM LONG
selects the packet type (PPDU format) with long PLCP.
```

[[:SOURce<hw>]:BB:WLAN:PLCP:LCBit:STATe <State>

The command sets the Locked Clock Bit in Service Field of the PLCP Header. The command is only available in framed mode (*SOURce:BB:WLAN:SMOD FRAMed*) and for physical layer mode CCK and PBCC (*SOURce:BB:WLAN:MODE CCK|PBCC*).

Parameters:

<State> 0|1|OFF|ON
 *RST: ON

Example:

BB:WLAN:PLCP:LCB:STAT OFF
 disables the Locked Clock Bit.

[:SOURCE<hw>]:BB:WLAN:PRESet

The command produces a standardized default for the IEEE 802.11a-g standard. The settings correspond to the *RST values specified for the commands.

Example:

BB:WLAN:PRES
 resets all the IEEE 802.11a-g settings to default values.

Usage:

Event

[:SOURCE<hw>]:BB:WLAN:SCRambler:MODE <Mode>

The command activates/deactivates the scrambler and selects the mode of determining the initialization value. The valid parameters depend on the selected physical layer mode (SOURCE:BB:WLAN:MODE OFDM | CCK | PBCC).

Parameters:

<Mode> OFF|ON|PONLy|RANDom|USER

OFF

The scrambler is deactivated.

RANDom

(OFDM only)The scrambler is activated. The initialization value of the scrambler is selected at random. Each frame has a different random initialization value. This value is also different in case of successive recalculations with the same setting parameters so that different signals are generated for each calculation.

USER

(OFDM only)The scrambler is activated. The initialization value of the scrambler is set to a fixed value that is entered at "Scrambler Init (hex)". This value is then identical in each generated frame.

ON

(CCK | PBCC only)The scrambler is activated.

PONLy

(CCK | PBCC only)The scrambler is activated. Only the data of the preamble is scrambled.

*RST: OFDM: RANDom; CCK/PBCC: ON

Example:

BB:WLAN:SCR OFF
 the scrambler is deactivated.

[[:SOURce<hw>]:BB:WLAN:SCRambler:PATtern <Pattern>

The command enters the initialization value for scrambling mode User. This value is then identical in each generated frame. The command is only available for physical layer mode OFDM (SOURce:BB:WLAN:MODE OFDM).

Parameters:

<Pattern> integer

Range: #H0,0 to #HFF,8
*RST: #H0,0

Example:

BB:WLAN:SCR USER
the scrambler is activated.
BB:WLAN:SCR:PATT #H3F,8
the initialization value is set.

[[:SOURce<hw>]:BB:WLAN:SERvice[:PATtern] <Pattern>

The command enters the value for service field The command is only available for physical layer mode OFDM (SOURce:BB:WLAN:MODE OFDM).

Parameters:

<Pattern> integer

Range: #H0,0 to #HFF,8
*RST: #H0,0

Example:

BB:WLAN:SERV:PATT #H3F,8
the value for the service field is set.

[[:SOURce<hw>]:BB:WLAN:SETTing:CATalog?

This command reads out the files with IEEE 802.11a-g settings in the default directory. The default directory is set using command MMEM:CDIRectory. Only files with the file extension *.wlan will be listed.

Return values:

<Catalog> string

Example:

MMEM:CDIR '<root>\user\wlan
sets the default directory to <root>\user\wlan.
BB:WLAN:SETT:CAT?
reads out all the files with IEEE 802.11a-g settings in the default directory.
Response: 'wlana', 'wlang'
the files wlana and wlang are available.

Usage: Query only

[[:SOURce<hw>]:BB:WLAN:SETTING:DELeTe <Filename>

This command deletes the selected file with IEEE 802.11a-g WLAN settings.. The directory is set using command `MME:CDIRECTORY`. A path can also be specified, in which case the files in the specified directory are read. The file extension may be omitted. Only files with the file extension `*.wlan` will be deleted.

Parameters:

<Filename> string

Example: `BB:WLAN:SETT:DEL 'wlana'`
deletes file `wlana`.

[[:SOURce<hw>]:BB:WLAN:SETTING:LOAD <Filename>

This command loads the selected file with IEEE 802.11a-g WLAN settings.. The directory is set using command `MME:CDIRECTORY`. A path can also be specified, in which case the files in the specified directory are read. The file extension may be omitted. Only files with the file extension `*.wlan` will be loaded.

Setting parameters:

<Filename> string

Example: `BB:WLAN:SETT:LOAD 'wlana'`
loads file `wlana`.

Usage: Setting only

[[:SOURce<hw>]:BB:WLAN:SETTING:STORE <Filename>

This command stores the current IEEE 802.11a-g WLAN settings into the selected file. The directory is set using command `MME:CDIRECTORY`. A path can also be specified, in which case the files in the specified directory are read. Only the file name has to be entered. IEEE 802.11a-g WLAN settings are stored as files with the specific file extensions `*.wlan`.

Setting parameters:

<Filename> string

Example: `BB:WLAN:SETT:STOR 'wlan_g'`
stores the current settings into file `wlan_g`.

Usage: Setting only

[[:SOURce<hw>]:BB:WLAN:SLENGth <Slength>

The command selects the number of frames. The command is only valid in framed mode (`SOURCE:BB:WLAN:SMODE FRAMED`).

Parameters:

<Slength> float
 Range: 1 frame to 511 frames
 *RST: 1

Example:

BB:WLAN:SLEN 4
 selects the generation of 4 frames.

[:SOURCE<hw>]:BB:WLAN:SMODE <Smode>

The command selects the simulation mode.

Parameters:

<Smode> FRAMED|UNFRamed

FRAMED

The framed mode is the standard operating mode which is also used in the real system. Data packets with the frame structure defined by the standard are generated.

UNFRamed

The "unframed mode" is offered in addition. In this mode, a non-packet-oriented signal without a frame structure is generated with the modulations and data rates defined by 802.11a-g.

*RST: FRAMED

Example:

BB:WLAN:SMOD UNFR
 selects unframed mode.

[:SOURCE<hw>]:BB:WLAN:STANDARD <Standard>

The command selects the standard according to which the signal is simulated.

Parameters:

<Standard>

STAN80211A|STAN80211B|STAN80211G

STAN80211A

The standard supports OFDM (orthogonal frequency division multiplexing). This modulation is defined by the IEEE 802.11a specification in the 5 GHz frequency band.

STAN80211B

The standard includes the modulation mode CCK (complementary code keying) and the data rates 5.5 Mbps and 11 Mbps. PBCC (packet binary convolutional coding) can optionally be used instead of CCK modulation for the 5.5 Mbps and 11 Mbps data rates.

STAN80211G

Standard 802.11g extends standard 802.11b with higher transmission rates. 802.11g contains the previous 802.11b modes and also integrates the OFDM method used in 802.11a for frequencies in the 2.4 GHz band.

*RST: STAN80211G

Example:

BB:WLAN:STAN STAN80211B

selects signal generation according to 802.11b.

[[:SOURce<hw>]:BB:WLAN:STATe <State>

The command activates modulation in accordance with the IEEE 802.11a-g WLAN standard. Activating this standard deactivates all the other digital standards and digital modulation modes (in case of two-path instruments, this affects the same path).

BB:WLAN:STAT ON deactivates the other standards and digital modulation.

Parameters:

<State>

0|1|OFF|ON

*RST: OFF

Example:

BB:WLAN:STAT ON

activates modulation in accordance with the IEEE 802.11a-g WLAN standard.

[[:SOURce<hw>]:BB:WLAN:TDWindowing:STATe <State>

The command activates/deactivates the time domain windowing. Time domain windowing is a method to influence the spectral characteristics of the signal, which is not stipulated by the standard. However, it does not replace oversampling and subsequent signal filtering. The command is only available for physical layer mode OFDM

(SOURce:BB:WLAN:MODE OFDM).

Parameters:

<State> 0|1|OFF|ON
 *RST: OFF

Example:

BB:WLAN:TDW:STAT OFF
 deactivates the time domain windowing.

[:SOURce<hw>]:BB:WLAN:TTIME <Ttime>

The command sets the transition time. The transition time defines the overlap range of two OFDM symbols when time domain windowing is active. At a setting of 100 ns, one sample overlaps. This command is only available in physical layer mode OFDM (SOURce:BB:WLAN:MODE OFDM) and with active time domain windowing (SOURce:BB:WLAN:TDWindowing:STATE ON).

Parameters:

<Ttime> float
 Range: 0 to 1000 ns
 Increment: 1 ns
 *RST: 100 ns

Example:

BB:WLAN:TTIM 10 ns
 sets a transition time of 10 ns.

4.2 Filter/Clipping Settings

[:SOURce<hw>]:BB:WLAN:CLIPping:LEVel.....	58
[:SOURce<hw>]:BB:WLAN:CLIPping:MODE.....	58
[:SOURce<hw>]:BB:WLAN:CLIPping:STATE.....	58
[:SOURce<hw>]:BB:WLAN:FILTer:TYPE.....	59
[:SOURce<hw>]:BB:WLAN:FILTer:ILENgtH.....	59
[:SOURce<hw>]:BB:WLAN:FILTer:ILENgtH:AUTO.....	59
[:SOURce<hw>]:BB:WLAN:FILTer:OSAMpling.....	60
[:SOURce<hw>]:BB:WLAN:FILTer:OSAMpling:AUTO.....	60
[:SOURce<hw>]:BB:WLAN:FILTer:PARAmeter:APCO25.....	60
[:SOURce<hw>]:BB:WLAN:FILTer:PARAmeter:COSSine.....	60
[:SOURce<hw>]:BB:WLAN:FILTer:PARAmeter:GAUSS.....	61
[:SOURce<hw>]:BB:WLAN:FILTer:PARAmeter:LPASS.....	61
[:SOURce<hw>]:BB:WLAN:FILTer:PARAmeter:LPASSEVM.....	61
[:SOURce<hw>]:BB:WLAN:FILTer:PARAmeter:PGAuss.....	62
[:SOURce<hw>]:BB:WLAN:FILTer:PARAmeter:RCOSine.....	62
[:SOURce<hw>]:BB:WLAN:FILTer:PARAmeter:SPHase.....	62
[:SOURce<hw>]:BB:WLAN:CRATe:VARiAtion.....	62

[:SOURce<hw>]:BB:WLAN:CLIPping:LEVel <Level>

The command sets the limit for level clipping. This value indicates at what point the signal is clipped. It is specified as a percentage, relative to the highest level. 100% indicates that clipping does not take place.

Level clipping is activated with the command `SOUR:BB:WLAN:CLIP:STAT ON`.

Parameters:

<Level> float
 Range: 0 PCT to 100 PCT
 Increment: 1
 *RST: 100 PCT

Example:

`BB:WLAN:CLIP:LEV 80PCT`
 sets the limit for level clipping to 80% of the maximum level.
`BB:WLAN:CLIP:STAT ON`
 activates level clipping.

[:SOURce<hw>]:BB:WLAN:CLIPping:MODE <Mode>

The command sets the method for level clipping (Clipping).

Parameters:

<Mode> VECTor|SCALar
VECTor
 The reference level is the amplitude $|i+jq|$.
SCALar
 The reference level is the absolute maximum of the I and Q values.
 *RST: VECTor

Example:

`BB:WLAN:CLIP:MODE SCAL`
 selects the absolute maximum of all the I and Q values as the reference level.
`BB:WLAN:CLIP:LEV 80PCT`
 sets the limit for level clipping to 80% of this maximum level.
`BB:WLAN:CLIP:STAT ON`
 activates level clipping.

[:SOURce<hw>]:BB:WLAN:CLIPping:STATe <State>

The command activates level clipping (Clipping). The value is defined with the command `[SOURce:]BB:WLAN:CLIPping:LEVel`, the mode of calculation with the command `[SOURce:]BB:WLAN:CLIPping:MODE`.

Parameters:

<State> 0|1|OFF|ON
 *RST: OFF

Example: `BB:WLAN:CLIP:STAT ON`
activates level clipping.

[[:SOURce<hw>]:BB:WLAN:FILTer:TYPE <Type>

The command selects the filter type.

Parameters:

<Type> RCOSine|COSine|GAUSs|LGAuss|CONE|COF705|
COEqualizer|COFequalizer|C2K3x|APCO25|SPHase|
RECTangle|PGAuss|LPASs|DIRac|ENPShape|EWPSshape|
LPASSEVM

*RST: Depends on layer mode

Example: `BB:WLAN:FILT:TYPE COS`
sets the filter type COSine.

[[:SOURce<hw>]:BB:WLAN:FILTer:ILENght <llength>

(for R&S WinIQSIM2 only)

The command sets the impulse length (number of filter tabs).

Parameters:

<llength> float

Range: 1 to 128

Increment: 1

*RST: 10

Example: `BB:WLAN:FILT:ILEN 10`
sets the number of filter tabs to 10.

[[:SOURce<hw>]:BB:WLAN:FILTer:ILENght:AUTO <Auto>

(for R&S WinIQSIM2 only)

The command activates/deactivates the impulse length state. If activated, the most sensible parameter values are selected. The value depends on the coherence check.

Parameters:

<Auto> 0|1|OFF|ON

*RST: ON

Example: `BB:WLAN:FILT:ILEN:AUTO ON`
the most sensible parameters are selected automatically.

[[:SOURce<hw>]:BB:WLAN:FILTer:OSAMpling <Osampling>

(for R&S WinIQSIM2 only)

The command sets the upsampling factor.

Parameters:

<Osampling> float
 Range: 1 to 32
 *RST: 32

Example: BB:WLAN:FILT:OSAM 32
 sets the upsampling factor to 32.

[[:SOURce<hw>]:BB:WLAN:FILTer:OSAMpling:AUTO <Auto>

(for R&S WinIQSIM2 only)

The command activates/deactivates the upsampling factor state. If activated, the most sensible parameter values are selected. The value depends on the coherence check. If deactivated, the values can be changed manually.

Parameters:

<Auto> 0|1|OFF|ON
 *RST: ON

Example: BB:WLAN:FILT:OSAM:AUTO ON
 the most sensible parameters are selected automatically.

[[:SOURce<hw>]:BB:WLAN:FILTer:PARAmeter:APCO25 <Apco25>

The command sets the roll-off factor for filter type APCO25.

Parameters:

<Apco25> float
 Range: 0.05 to 0.99
 Increment: 0.01
 *RST: 0.2

Example: BB:WLAN:PAR:APCO25 0.2
 sets the roll-off factor to 0.2 for filter type APCO25.

[[:SOURce<hw>]:BB:WLAN:FILTer:PARAmeter:COSSine <Cosine>

The command sets the roll-off factor for the Cosine filter type.

Parameters:

<Cosine> float

Range: 0.05 to 0.99
 Increment: 0.01
 *RST: 0.35

Example:

BB:WLAN:PAR: COS 0.35
 sets the roll-off factor to 0.35 for filter type Cosine.

[:SOURce<hw>]:BB:WLAN:FILTER:PARAMeter:GAUSSs <Gauss>

The command sets the roll-off factor for the Gauss filter type.

Parameters:

<Gauss> float

Range: 0.15 to 2.5
 Increment: 0.01
 *RST: 0.5

Example:

BB:WLAN:PAR: COS 0.5
 sets B x T to 0.5 for the Gauss filter type.

[:SOURce<hw>]:BB:WLAN:FILTER:PARAMeter:LPASSs <LPass>

The command sets the cut off frequency factor for the Lowpass filter (ACP optimization) type.

Parameters:

<LPass> float

Range: 0.05 to 2
 *RST: 0.5

Example:

BB:WLAN:FILT:PAR:LPAS 0.5
 the cut of frequency factor is set to 0.5.

[:SOURce<hw>]:BB:WLAN:FILTER:PARAMeter:LPASSEVM <LPassevm>

The command sets the cut off frequency factor for the Lowpass filter (EVM optimization) type.

Parameters:

<LPassevm> float

Range: 0.05 to 2.0
 *RST: 0.5

Example: `BB:WLAN:FILT:PAR:LPASSEVM 0.5`
the cut of frequency factor is set to 0.5.

[:SOURce<hw>]:BB:WLAN:FILT:PAR:PGAuss <PGauss>

The command sets the roll-off factor for filter type Pure Gauss.

Parameters:

<PGauss> float
Range: 0.15 to 2.5
*RST: 0.5

Example: `BB:WLAN:PAR:PG 0.2`
sets the roll-off factor

[:SOURce<hw>]:BB:WLAN:FILT:PAR:RCOSine <RCosine>

The command sets the roll-off factor for the Root Cosine filter type.

Parameters:

<RCosine> float
Range: 0 to 0.99
Increment: 0.01
*RST: 0.22

Example: `BB:WLAN:PAR:RCOS 0.22`
sets the roll-off factor to 0.22 for filter type Root Cosine.

[:SOURce<hw>]:BB:WLAN:FILT:PAR:SPHase <SPHase>

The command sets B x T for the Split Phase filter type.

Parameters:

<SPHase> float
Range: 0.15 to 2.5
Increment: 0.01
*RST: 2

Example: `BB:WLAN:PAR:SPH 0.5`
sets B x T to 0.5 for the Split Phase filter type.

[:SOURce<hw>]:BB:WLAN:CRATE:VARIation <Variation>

The command enters the output chip rate.

Parameters:

<Variation> float

Range: 1 kcps to 40 Mcps
 Increment: 1 Hz
 *RST: 802.11a: 20 Mcps; 802.11b: 11 Mcps; 802.11g: 11 Mcps

Example:

BB:WLAN:CRAT:VAR 4086001
 'sets the output chip rate to 4.08 Mcps.

4.3 Trigger Settings



The trigger settings are available for R&S SMx and R&S AMU instruments only.

EXTernal<ch>

The numeric suffix to **EXTernal<ch>** distinguishes between the external trigger via the TRIGGER 1 (suffix 1) and TRIGGER 2 (suffix 2) connector.

[:SOURce<hw>]:BB:WLAN:TRIGger:ARM:EXECute	63
[:SOURce<hw>]:BB:WLAN:TRIGger:EXECute	64
[:SOURce<hw>]:BB:WLAN:TRIGger:EXTernal:SYNChronize:OUTPut	64
[:SOURce<hw>]:BB:WLAN:TRIGger:OBASeband:DELay	65
[:SOURce<hw>]:BB:WLAN:TRIGger:OBASeband:INHibit	65
[:SOURce<hw>]:BB:WLAN:TRIGger:RMODE	66
[:SOURce<hw>]:BB:WLAN:TRIGger:SLENgth	66
[:SOURce<hw>]:BB:WLAN:TRIGger:SLUNit	67
[:SOURce<hw>]:BB:WLAN:TRIGger:SOURce	67
[:SOURce<hw>]:BB:WLAN:TRIGger[:EXTernal<ch>]:DELay	68
[:SOURce<hw>]:BB:WLAN:TRIGger[:EXTernal<ch>]:INHibit	68
[:SOURce<hw>]:BB:WLAN[:TRIGger]:SEQuence	69

[:SOURce<hw>]:BB:WLAN:TRIGger:ARM:EXECute

The command stops signal generation for trigger modes Armed_Auto and Armed_Ret-rigger. A subsequent internal or external trigger event restart signal generation.

Example:

```
BB:WLAN:TRIG:SOUR INT
sets internal triggering.
BB:WLAN:TRIG:SEQ ARET
sets Armed_Retrigger mode, i.e. every trigger event causes signal
generation to restart.
BB:WLAN:TRIG:EXEC
executes a trigger, signal generation is started.
BB:WLAN:TRIG:ARM:EXEC
signal generation is stopped.
BB:WLAN:TRIG:EXEC
executes a trigger, signal generation is started again.
```

Usage: Event

[:SOURce<hw>]:BB:WLAN:TRIGger:EXECute

The command executes a trigger. The internal trigger source must be selected using the command `:BB:WLAN:TRIG:SOUR INT` and a trigger mode other than `AUTO` must be selected using the command `:BB:WLAN:TRIG:SEQ`.

Example:

```
BB:WLAN:TRIG:SOUR INT
sets internal triggering.
BB:WLAN:TRIG:SEQ RETR
sets "Retrigger" mode, i.e. every trigger event causes signal gen-
eration to restart.
BB:WLAN:TRIG:EXEC
executes a trigger.
```

Usage: Event

[:SOURce<hw>]:BB:WLAN:TRIGger:EXTernal:SYNChronize:OUTPut <Output>

(enabled for "Trigger Source" External)

Enables/disables output of the signal synchronous to the external trigger event.

For R&S SMBV instruments:

See also section "Sync. Output to External Trigger" for a detailed description of the applications of this setting.

Parameters:

<Output>

0|1|OFF|ON

ON

The signal calculation starts simultaneously with the external trigger event but because of the instrument's processing time the first samples are cut off and no signal is outputted. After elapsing of the internal processing time, the output signal is synchronous to the trigger event.

OFF

The signal output begins after elapsing of the processing time and starts with sample 0, i.e. the complete signal is outputted. This mode is recommended for triggering of short signal sequences with signal duration comparable with the processing time of the instrument.

*RST: ON

Example:

BB:WLAN:TRIG:SOUR EXT

sets external triggering.

BB:WLAN:TRIG:EXT:SYNC:OUTP ON

enables synchronous output to external trigger.

[:SOURce<hw>]:BB:WLAN:TRIGger:OBASband:DELay <Delay>

The command specifies the trigger delay (expressed as a number of chips) for triggering by the trigger signal from the second path.

Parameters:

<Delay>

float

Range: 0 chips to $2^{32}-1$ chips

Increment: 1 chip

*RST: 0 chips

Example:

BB:WLAN:TRIG:SOUR OBAS

sets for path A the internal trigger executed by the trigger signal from the second path (path B).

BB:WLAN:TRIG:OBAS:DEL 50

sets a delay of 50 chips for the trigger.

[:SOURce<hw>]:BB:WLAN:TRIGger:OBASband:INHibit <Inhibit>

The command specifies the number of chips by which a restart is to be inhibited following a trigger event. This command applies only for triggering by the second path.

Parameters:

<Inhibit> float
 Range: 0 to 2³²-1 chips
 Increment: 1 chip
 *RST: 0 chips

Example:

BB:WLAN:TRIG:SOUR OBAS
 sets for path A the internal trigger executed by the trigger signal from the second path (path B).
 BB:WLAN:TRIG:INH 200
 sets a restart inhibit for 200 chips following a trigger event.

[[:SOURce<hw>]:BB:WLAN:TRIGger:RMODE?

The command queries the current status of signal generation for all trigger modes with IEEE 802.11a-g WLAN modulation on.

Return values:

<RMode> STOP|RUN
RUN
 the signal is generated. A trigger event occurred in the triggered mode.
STOP
 the signal is not generated. A trigger event did not occur in the triggered modes, or signal generation was stopped by the command :BB:WLAN:TRIG:ARM:EXECute (armed trigger modes only).

Example:

BB:WLAN:TRIG:SOUR EXT
 sets external triggering via the TRIGGER 1 connector.
 BB:WLAN:TRIG:MODE ARET
 selects the "Armed_Retrigger" mode.
 BB:WLAN:TRIG:RMODE?
 queries the current status of signal generation.
 Response: RUN
 the signal is generated, an external trigger was executed.

Usage: Query only

[[:SOURce<hw>]:BB:WLAN:TRIGger:SLENgth <SLength>

The command defines the length of the signal sequence to be output in the "Single" trigger mode (SOUR:BB:WLAN:SEQ SING). The input is made in terms of chips.

It is possible to output deliberately just part of the frame, an exact sequence of the frame, or a defined number of repetitions of the frame.

Parameters:

<SLength> float
 Range: 1 to (2³²-1) chips
 Increment: 1 chip
 *RST: 32 768 chips

Example:

```
BB:WLAN:SEQ SING
sets trigger mode Single.
:BB:WLAN:TRIG:SLEN 200
sets a sequence length of 200 chips. The first 200 chips of the
current frame will be output after the next trigger event.
```

[:SOURCE<hw>]:BB:WLAN:TRIGGER:SLUNIT <Slunit>

The command defines the unit for the entry of the length of the signal sequence (SOUR:BB:WLAN:TRIG:SLEN) to be output in the "Single" trigger mode (SOUR:BB:WLAN:SEQ SING).

Parameters:

<Slunit> FRAME|CHIP|SEQUENCE
FRAME
 Unit Frame. A single frame is generated after a trigger event.
CHIP
 Unit Chip. A single chip is generated after a trigger event.
SEQUENCE
 Unit Sequence Length. A single sequence is generated after a trigger event.
 *RST: SEQUENCE

Example:

```
BB:WLAN:SEQ SING
sets trigger mode Single.
BB:WLAN:TRIG:SLUN FRAM
sets unit Frame for the entry of sequence length.
BB:WLAN:TRIG:SLEN 2
sets a sequence length of 2 frame. Two frames will be output after
the next trigger event.
```

[:SOURCE<hw>]:BB:WLAN:TRIGGER:SOURCE <Source>

The command selects the trigger source.

Parameters:

<Source>

INTernal|EXTernal|BEXTernal|OBASeband

INTernal

Triggering is executed by means of the Trigger command `SOURce<[1] | 2>:BB:WLAN:TRIGger:EXECute` or `*TRG` in the case of remote control and by means of "Execute Trigger" in the case of manual operation.

EXTernal

Triggering is executed by means of the signal on the TRIGGER 1 connector.

BEXTernal

Triggering is executed by means of the signal on the TRIGGER 2 connector.

OBASeband

Triggering is executed by means of the trigger signal from the second path (two-path instruments only).

Example:

```
BB:WLAN:TRIG:SOUR EXT
sets external triggering via the TRIGGER 1 connector.
```

[:SOURce<hw>]:BB:WLAN:TRIGger[:EXTernal<ch>]:DELay <Delay>

The command specifies the trigger delay (expressed as a number of chips) for external triggering. The numeric suffix to EXTernal distinguishes between the external trigger via the TRIGGER 1 (suffix 1) and TRIGGER 2 (suffix 2) connector.

Parameters:

<Delay>

float

Range: 0 chips to $2^{32}-1$ chips

Increment: 1 chip

*RST: 0 chips

Example:

```
BB:WLAN:TRIG:SOUR EXT
sets an external trigger via the TRIGGER 1 connector.
BB:WLAN:TRIG:DEL 50
sets a delay of 50 chips for the trigger.
```

[:SOURce<hw>]:BB:WLAN:TRIGger[:EXTernal<ch>]:INHibit <Inhibit>

The command specifies the number of chips by which a restart is to be inhibited following a trigger event. This command applies only in the case of external triggering. The numeric suffix to EXTernal distinguishes between the external trigger via the TRIGGER 1 (suffix 1) and TRIGGER 2 (suffix 2) connector.

Parameters:

<Inhibit> float
 Range: 0 to 2³²-1 chips
 Increment: 1 chip
 *RST: 0 chips

Example:

BB:WLAN:TRIG:SOUR EXT
 selects an external trigger via the TRIGGER 1 connector.
 BB:WLAN:TRIG:INH 200
 sets a restart inhibit for 200 chips following a trigger event.

[:SOURCE<hw>]:BB:WLAN[:TRIGGER]:SEQUENCE <Sequence>

The command selects the trigger mode.

Parameters:

<Sequence> AUTO|RETRigger|AAUTo|ARETrigger|SINGLE

AUTO

The modulation signal is generated continuously.

RETRigger

The modulation signal is generated continuously. A trigger event (internal or external) causes a restart.

AAUTo

The modulation signal is generated only when a trigger event occurs. After the trigger event the signal is generated continuously. Signal generation is stopped with command "SOUR:BB:WLAN:TRIG:ARM:EXEC" and started again when a trigger event occurs.

ARETrigger

The modulation signal is generated only when a trigger event occurs. The device automatically toggles to RETRIG mode. Every subsequent trigger event causes a restart.

Signal generation is stopped with command

SOUR:BB:WLAN:TRIG:ARM:EXEC and started again when a trigger event occurs.

SINGLE

The modulation signal is generated only when a trigger event occurs. Then the signal is generated once to the length specified with command SOUR:BB:WLAN:TRIG:SLEN. Every subsequent trigger event causes a restart.

*RST: AUTO

Example:

BB:WLAN:SEQ AAUT
 sets the "Armed_auto" trigger mode; the device waits for the first trigger (e.g. with *TRG) and then generates the signal continuously.

4.4 Marker Settings

This section lists the remote control commands, necessary to configure the markers.



The marker delay settings are available for R&S SMx and R&S AMU instruments only.

OUTPut<ch>

The numeric suffix to `OUTPut` distinguishes between the available markers.

Only two markers are available for the R&S SMBV, i.e. the allowed values for the suffix are 1 or 2.

<code>[:SOURce<hw>]:BB:WLAN:TRIGger:OUTPut:DELay:FIXed</code>	70
<code>[:SOURce<hw>]:BB:WLAN:TRIGger:OUTPut<ch>:DELay</code>	70
<code>[:SOURce<hw>]:BB:WLAN:TRIGger:OUTPut<ch>:DELay:MAXimum</code>	71
<code>[:SOURce<hw>]:BB:WLAN:TRIGger:OUTPut<ch>:DELay:MINimum</code>	71
<code>[:SOURce<hw>]:BB:WLAN:TRIGger:OUTPut<ch>:MODE</code>	72
<code>[:SOURce<hw>]:BB:WLAN:TRIGger:OUTPut<ch>:ONTime</code>	73
<code>[:SOURce<hw>]:BB:WLAN:TRIGger:OUTPut<ch>:OFFTime</code>	73
<code>[:SOURce<hw>]:BB:WLAN:TRIGger:OUTPut<ch>:PATTern</code>	73
<code>[:SOURce<hw>]:BB:WLAN:TRIGger:OUTPut<ch>:PULSe:DIVider</code>	73
<code>[:SOURce<hw>]:BB:WLAN:TRIGger:OUTPut<ch>:PULSe:FREQuency</code>	74

`[:SOURce<hw>]:BB:WLAN:TRIGger:OUTPut:DELay:FIXed` <Fixed>

(for R&S SMx/AMU instruments only)

The command restricts the marker delay setting range to the dynamic range. In this range the delay can be set without restarting the marker and signal. If a delay is entered in setting ON but is outside this range, the maximum possible delay is set and an error message is generated.

Parameters:

<Fixed> 0|1|OFF|ON
 *RST: OFF

Example:

`BB:WLAN:TRIG:OUTP:DEL:FIX ON`
 restricts the marker signal delay setting range to the dynamic range.

`[:SOURce<hw>]:BB:WLAN:TRIGger:OUTPut<ch>:DELay` <Delay>

(for R&S SMx/AMU instruments only)

The command defines the delay between the signal on the marker outputs and the start of the signal, expressed in terms of chips. Command `:BB:WLAN:TRIGger:OUTPut:DElay:FIXed` can be used to restrict the range of values to the dynamic range, i.e. the range within which a delay of the marker signals can be set without restarting the marker and signal.

Parameters:

<Delay> float
 Range: 0 to $2^{32} - 1$ chips
 Increment: 1 chip
 *RST: 0

Example:

`BB:WLAN:TRIG:OUTP2:DEL 1600`
 sets a delay of 1600 chips for the signal on connector MARKER 2.

[[:SOURce<hw>]:BB:WLAN:TRIGger:OUTPut<ch>:DElay:MAXimum?

(for R&S SMx/AMU instruments only)

The command queries the maximum marker delay for setting `:BB:WLAN:TRIG:OUTP:DEL:FIX ON`.

Return values:

<Maximum> float

Example:

`BB:WLAN:TRIG:OUTP:DEL:FIX ON`
 restricts the marker signal delay setting range to the dynamic range.
`BB:WLAN:TRIG:OUTP:DEL:MAX`
 queries the maximum of the dynamic range.
 Response: 2000
 the maximum for the marker delay setting is 2000 chips.

Usage: Query only

[[:SOURce<hw>]:BB:WLAN:TRIGger:OUTPut<ch>:DElay:MINimum?

(for R&S SMx/AMU instruments only)

The command queries the minimum marker delay for setting `:BB:WLAN:TRIGger:OUTPut:DElay:FIXed ON`.

Return values:

<Minimum> float

Example: `BB:WLAN:TRIG:OUTP:DEL:FIX ON`
restricts the marker signal delay setting range to the dynamic range.

`BB:WLAN:TRIG:OUTP:DEL:MIN`
queries the minimum of the dynamic range.

Response: "0"
the minimum for the marker delay setting is 0 chips.

Usage: Query only

[:SOURce<hw>]:BB:WLAN:TRIGger:OUTPut<ch>:MODE <Mode>

The command defines the signal for the selected marker output.

Parameters:

<Mode>

REStart|FRAMe|FACTive|PULSe|PATTern|RATio|TRIGger

REStart

A marker signal is generated at the start of each signal sequence (period = selected number of frames; the sequence length is set with command `SOUR:BB:WLAN:FCOUNT`).

FRAMe

A marker signal is generated at the start of each frame (period = PPDU + idle time).

FACTive

A marker signal is generated at the start of every active part of the frame.

The active data transfer part (PPDU) of a frame period is marked with high, the inactive part (idle time) with low. This marker can be used to decrease the carrier leakage during inactive signal parts by feeding it into the pulse modulator.

PATTern

A marker signal is generated according to the user defined pattern (command `SOURce:BB:WLAN:TRIGger:OUTPut:PATTern`).

PULSe

A pulsed marker signal is generated. The pulse frequency (= symbol rate/divider) is defined with the `SOUR:BB:WLAN:TRIG:OUTP:PULSe:DIVider` command and can be queried with the `SOUR:BB:WLAN:TRIG:OUTP:PULSe:FREQuency?` command.

RATio

A marker signal corresponding to the Time Off / Time On specifications in the commands `SOURce:BB:WLAN:TRIGger:OUTPut:OFFT` and `SOURce:BB:WLAN:TRIGger:OUTPut:ONT` is generated.

*RST: REStart

Example: `BB:WLAN:TRIG:OUTP2:MODE FRAM`
selects the frame marker signal on output MARKER 2.

[:SOURce<hw>]:BB:WLAN:TRIGger:OUTPut<ch>:ONTime <OnTime>
[:SOURce<hw>]:BB:WLAN:TRIGger:OUTPut<ch>:OFFTime <OffTime>

The command sets the number of chips in a period (ON time + OFF time) during which the marker signal in setting `SOURce:BB:WLAN:TRIGger:OUTPut:MODE RATIo` on the marker outputs is OFF.

Parameters:

<OffTime> float
Range: 1 to 16777215
Increment: 1
*RST: 1

Example: `BB:WLAN:TRIG:OUTP2:OFFT 200`
sets an OFF time of 200 chips for marker signal 2.

[:SOURce<hw>]:BB:WLAN:TRIGger:OUTPut<ch>:PATTern <Pattern>

The command defines the bit pattern used to generate the marker signal in the setting `SOURce:BB:WLAN:TRIGger:OUTPut:MODE PATTern`. 0 is marker off, 1 is marker on.

Parameters:

<Pattern> 32 bit pattern
*RST: #B,1

Example: `BB:WLAN:TRIG:OUTP2:PATT #B000000011111111,15`
sets a bit pattern.
`BB:WLAN:TRIG:OUTP2:MODE PATT`
activates the marker signal according to a bit pattern on output MARKER 2.

[:SOURce<hw>]:BB:WLAN:TRIGger:OUTPut<ch>:PULSe:DIVider <Divider>

The command sets the divider for Pulse marker mode (`SOUR:BB:WLAN:TRIG:OUTP:MODE PULSe`). The resulting pulse frequency is derived by dividing the symbol rate by the divider.

Parameters:

<Divider> float
Range: 2 to 1024
Increment: 1
*RST: 2

Example: `BB:WLAN:TRIG:OUTP2:PULS:DIV 2`
 sets the divider to 2 for the marker signal on output MARKER 2.
`BB:WLAN:TRIG:OUTP2:FREQ?`
 queries the resulting pulse frequency of the marker signal.
 Response: "66 000"
 the resulting pulse frequency is 66 kHz.

[[:SOURce<hw>]:BB:WLAN:TRIGger:OUTPut<ch>:PULSe:FREQuency?

The command queries the pulse frequency of the pulsed marker signal in the setting `SOURce:BB:WLAN:TRIGger:OUTPut:MODE PULSe`. The pulse frequency is derived by dividing the symbol rate by the divider.

Return values:

<Frequency> float

Example: `BB:WLAN:TRIG:OUTP2:PULS:DIV 2`
 sets the divider marker signal on output MARKER 2 to the value 2.
`BB:WLAN:TRIG:OUTP2:MODE PULS`
 enables the pulsed marker signal.
`BB:WLAN:TRIG:OUTP2:PULS:FREQ?`
 queries the pulse frequency of the marker signal.
 Response: "33 000"
 the resulting pulse frequency is 33 kHz.

Usage: Query only

4.5 Clock Settings

This section lists the remote control commands, necessary to configure the clock.



The clock settings are available for R&S SMx and R&S AMU instruments only.

<code>[[:SOURce<hw>]:BB:WLAN:CLOCK:MODE</code>	74
<code>[[:SOURce<hw>]:BB:WLAN:CLOCK:MULTiplier</code>	75
<code>[[:SOURce<hw>]:BB:WLAN:CLOCK:SOURce</code>	75
<code>[[:SOURce<hw>]:BB:WLAN:CLOCK:SYNChronization:EXECute</code>	76
<code>[[:SOURce<hw>]:BB:WLAN:CLOCK:SYNChronization:MODE</code>	76

[[:SOURce<hw>]:BB:WLAN:CLOCK:MODE <Mode>

The command enters the type of externally supplied clock (`:BB:WLAN:CLOCK:SOURce EXTERNAL`).

When `MCHip` is used, a multiple of the chip clock is supplied via the `CLOCK` connector and the chip clock is derived internally from this. The multiplier is entered with the command `[:SOURce<hw>] :BB:WLAN:CLOCK:MULTiplier`.

For two-path instruments, the only numerical suffix allowed for `SOURce` is 1, since the external clock source is permanently allocated to path A.

Parameters:

<Mode> CHIP|MCHip
*RST: CHIP

Example:

`BB:WLAN:CLOC:MODE CHIP`
selects clock type "Chip", i.e. the supplied clock is a chip clock.

[:SOURce<hw>] :BB:WLAN:CLOCK:MULTiplier <Multiplier>

The command specifies the multiplier for clock type "Multiplied" (`:BB:WLAN:CLOCK:MODE MCHip`) in the case of an external clock source.

For two-path instruments, the only numerical suffix allowed for `SOURce` is 1, since the external clock source is permanently allocated to path A.

Parameters:

<Multiplier> float
Range: 1 to 64
Increment: 1
*RST: 4

Example:

`BB:WLAN:CLOC:SOUR EXT`
selects the external clock source. The clock is supplied via the `CLOCK` connector.
`BB:WLAN:CLOC:MODE MCH`
selects clock type Multiplied, i.e. the supplied clock has a rate which is a multiple of the chip rate.
`BB:WLAN:CLOC:MULT 12`
the multiplier for the external clock rate is 12.

[:SOURce<hw>] :BB:WLAN:CLOCK:SOURce <Source>

The command selects the clock source.

For two-path instruments, selecting `EXTernal` is only possible for path A, since the external clock source is permanently allocated to path A; selecting `AINternal` is only possible for path B.

Parameters:

<Source> INTernal|EXTernal|AINternal

INTernal

The internal clock reference is used.

EXTernal

The external clock reference is supplied to the CLOCK connector.

*RST: INTernal

Example:

BB:WLAN:CLOC:SOUR EXT

selects an external clock reference. The clock is supplied via the CLOCK connector.

BB:WLAN:CLOC:MODE CHIP

specifies that a chip clock is supplied via the CLOCK connector.

[:SOURce<hw>]:BB:WLAN:CLOCK:SYNChronization:EXECute

(for R&S SMBV only)

Performs automatic adjustment of the instrument's settings required for the synchronization mode, set with the command `[:SOURce<hw>]:BB:WLAN:CLOCK:SYNChronization:MODE`.

Example:

:BB:WLAN:CLOC:SYNC:MODE MAST

the instrument is configured to work as a master one.

:BB:WLAN:CLOC:SYNC:EXEC

all synchronization's settings are adjusted accordingly.

Usage:

Event

[:SOURce<hw>]:BB:WLAN:CLOCK:SYNChronization:MODE <Mode>

(for R&S SMBV only)

Selects the synchronization mode.

This parameter is used to enable generation of very precise synchronous signal of several connected R&S SMBVs.

Note: If several instruments are connected, the connecting cables from the master instrument to the slave one and between each two consecutive slave instruments must have the same length and type.

Avoid unnecessary cable length and branching points.

Parameters:

<Mode> NONE|MASTer|SLAVe

NONE

The instrument is working in stand-alone mode.

MASTer

The instrument provides all connected instrument with its synchronization (including the trigger signal) and reference clock signal.

SLAVe

The instrument receives the synchronization and reference clock signal from another instrument working in a master mode.

*RST: NONE

Example:

```
BB:WLAN:CLOC:SYNC:MODE MAST
```

the instrument is configured to work as a master one.

4.6 PSDU Settings

The `SOURCE:BB:WLAN:PSDU` system contains commands for setting the characteristics of the data packet on the physical layer (PPDU).

<code>[SOURce<hw>]:BB:WLAN:PSDU:BRATe</code>	78
<code>[SOURce<hw>]:BB:WLAN:PSDU:BSPReading:STATe</code>	78
<code>[SOURce<hw>]:BB:WLAN:PSDU:DATA</code>	78
<code>[SOURce<hw>]:BB:WLAN:PSDU:DATA:DSElect</code>	79
<code>[SOURce<hw>]:BB:WLAN:PSDU:DATA:PATtern</code>	79
<code>[SOURce<hw>]:BB:WLAN:PSDU:DLENgth</code>	80
<code>[SOURce<hw>]:BB:WLAN:PSDU:MAC:ADDRess<ch></code>	80
<code>[SOURce<hw>]:BB:WLAN:PSDU:MAC:ADDRess<ch>:STATe</code>	80
<code>[SOURce<hw>]:BB:WLAN:PSDU:MAC:DID</code>	81
<code>[SOURce<hw>]:BB:WLAN:PSDU:MAC:FCONtrol</code>	81
<code>[SOURce<hw>]:BB:WLAN:PSDU:MAC:FCONtrol:FDS</code>	81
<code>[SOURce<hw>]:BB:WLAN:PSDU:MAC:FCONtrol:MDATa</code>	82
<code>[SOURce<hw>]:BB:WLAN:PSDU:MAC:FCONtrol:MFRagments</code>	82
<code>[SOURce<hw>]:BB:WLAN:PSDU:MAC:FCONtrol:ORDER</code>	82
<code>[SOURce<hw>]:BB:WLAN:PSDU:MAC:FCONtrol:PMAngement</code>	82
<code>[SOURce<hw>]:BB:WLAN:PSDU:MAC:FCONtrol:PVERsion</code>	82
<code>[SOURce<hw>]:BB:WLAN:PSDU:MAC:FCONtrol:RETRY</code>	82
<code>[SOURce<hw>]:BB:WLAN:PSDU:MAC:FCONtrol:SUBType</code>	82
<code>[SOURce<hw>]:BB:WLAN:PSDU:MAC:FCONtrol:TDS</code>	82
<code>[SOURce<hw>]:BB:WLAN:PSDU:MAC:FCONtrol:TYPE</code>	82
<code>[SOURce<hw>]:BB:WLAN:PSDU:MAC:FCONtrol:WEP</code>	82
<code>[SOURce<hw>]:BB:WLAN:PSDU:MAC:FCSequence:STATe</code>	82
<code>[SOURce<hw>]:BB:WLAN:PSDU:MAC:SCONtrol:FRAGment:INCRement</code>	83
<code>[SOURce<hw>]:BB:WLAN:PSDU:MAC:SCONtrol:FRAGment:START</code>	83
<code>[SOURce<hw>]:BB:WLAN:PSDU:MAC:SCONtrol:SEQuence:INCRement</code>	83
<code>[SOURce<hw>]:BB:WLAN:PSDU:MAC:SCONtrol:SEQuence:START</code>	84

<code>[:SOURCE<hw>]:BB:WLAN:PSDU:MAC:SCONtrol:STATe</code>	84
<code>[:SOURCE<hw>]:BB:WLAN:PSDU:MAC:STATe</code>	84
<code>[:SOURCE<hw>]:BB:WLAN:PSDU:MODulation</code>	85
<code>[:SOURCE<hw>]:BB:WLAN:PSDU:SCOunt</code>	85

`[:SOURCE<hw>]:BB:WLAN:PSDU:BRATe <Brate>`

The command selects the bit rate of the PSDU. The available values depend on the selected physical layer mode. Value 1MBPS is available only for selection of long PLCP format in physical layer modes CCK and PBCC.

Parameters:

<Brate> 6MBPS|9MBPS|12MBPS|18MBPS|24MBPS|36MBPS|48MBPS|
54MBPS

*RST: OFDM: 54MBPS; CCK|PBCC: 11MBPS

Example:

```
BB:WLAN:MODE
selects physical layer mode OFDM.
BB:WLAN:PSDU:BRAT 12MBPS
sets a bit rate of 12MBPS.
```

`[:SOURCE<hw>]:BB:WLAN:PSDU:BSPrEading:STATe <State>`

The command activates/deactivates barker spreading. The command is only available only for selection of bit rates 1MBPS or 2 MBPS in physical layer modes CCK and PBCC.

Parameters:

<State> 0|1|OFF|ON

*RST: ON

Example:

```
BB:WLAN:MODE CCK
selects physical layer mode CCK.
BB:WLAN:PSDU:PLCP:FORM LONG
selects long PLCP format.
BB:WLAN:PSDU:BRAT 1MBPS
sets a bit rate of 1MBPS.
BB:WLAN:PSDU:BSPr OFF
deactivates barker spreading.
```

`[:SOURCE<hw>]:BB:WLAN:PSDU:DATA <Data>`

The command determines the data source for the data field.

Parameters:

<Data> PN9|PN15|PN16|PN20|PN21|PN23|DLIS|ZERO|ONE|PATTERN

PNxx

The pseudo-random sequence generator is used as the data source. Different random sequence lengths can be selected.

DLIS

A data list is used. The data list is selected with the command `[:SOURce<hw>] :BB:WLAN:PSDU:DATA:DSElect`.

ZERO | ONE

Internal 0 and 1 data is used.

PATTERN

Internal data is used. The bit pattern for the data is defined by the command `[:SOURce<hw>] :BB:WLAN:PSDU:DATA:PATTERN`.

*RST: PN9

Example:

```
BB:WLAN:PSDU:DATA PATT
selects as the data source for the data fields of burst 0, the bit
pattern defined with the following command.
BB:WLAN:PSDU:DATA:PATT #H3F,8
defines the bit pattern.
```

[:SOURce<hw>] :BB:WLAN:PSDU:DATA:DSElect <DSelect>

The command selects the data list for the DLIS data source selection.

The lists are stored as files with the fixed file extensions `*.dm_iqd` in a directory of the user's choice. The directory applicable to the following commands is defined with the command `MMEMoRY:CDIR`. To access the files in this directory, you only have to give the file name, without the path and the file extension.

Parameters:

<DSelect> string

Example:

```
BB:WLAN:PSDU:DATA DLIS
selects the Data Lists data source.
MMEMoRY:CDIR '<root>\Lists\DM\IqData'
selects the directory for the data lists.
BB:WLAN:PSDU:MAC:DATA:DLIS 'wlan_list1'
selects file 'wlan_list1' as the data source. This file must be in the
directory <root>\Lists\DM\IqData and have the file extension
*.dm_iqd.
```

[:SOURce<hw>] :BB:WLAN:PSDU:DATA:PATTERN <Pattern>

The command determines the bit pattern for the PATTERN selection. The maximum length is 64 bits.

Parameters:

<Pattern> 64 bit pattern
 *RST: 0

Example:

BB:WLAN:PSDU:MAC:DATA:PATT #H3F,8
 defines the bit pattern.

[:SOURce<hw>]:BB:WLAN:PSDU:DLENGth <Dlength>

The command sets the data length in bytes. In the framed mode, data field lengths of up to 4095 bytes are possible. This corresponds to the maximum data length. The unframed mode offers a data length of up to 100000 bytes.

If the data field length is changed, the generator calculates the number of OFDM data symbols as a function of the set PSDU bit rate ([:SOURce<hw>] :BB:WLAN:PSDU:SCOut).

Parameters:

<Dlength> float
 Range: 0 to 4095 Bytes (framed); 100000 Bytes (unframed)
 *RST: 100Bytes (OFDM); 1024Bytes (CCK|PBCC)

Example:

BB:WLAN:PSDU:DATA:LENG 256
 sets a data length of 256.

[:SOURce<hw>]:BB:WLAN:PSDU:MAC:ADDRess<ch> <Address>

The command enters the value of the address fields 1 ... 4. Exactly 48 bits must be entered. Each address is 6 bytes (48 bit) long. The addresses can be entered in hexadecimal form in the entry field of each address field. The least significant byte (LSB) is in left notation.

The MAC header can only be configured in framed mode (SOURce:BB:WLAN:SMODE FRAMed).

Parameters:

<Address> integer
 Range: #H000000000000,48 to #HFFFFFFFFFFFF,48
 *RST: #H000000000000,48

Example:

BB:WLAN:PSDU:MAC:ADDR2 #H124836C7EA54,48
 set the value for address field 2.

[:SOURce<hw>]:BB:WLAN:PSDU:MAC:ADDRess<ch>:STATe <State>

The command activates/deactivates the selected address field.

The MAC header can only be configured in framed mode (SOURCE:BB:WLAN:SMODE FRAMED).

Parameters:

<State> 0|1|OFF|ON
*RST: OFF

Example:

BB:WLAN:PSDU:MAC:ADDR2:STAT ON
activates generation of address field 2.

[:SOURCE<hw>]:BB:WLAN:PSDU:MAC:DID <Did>

The command enters the value of the duration Id field. Depending on the frame type, the 2-byte field Duration/ID is used to transmit the association identity of the station transmitting the frame or it indicates the duration assigned to the frame type. Exactly 16 bit must be entered.

The MAC header can only be configured in framed mode (SOURCE:BB:WLAN:SMODE FRAMED).

Parameters:

<Did> integer
Range: #H0000,16 to #FFFFFF,16
*RST: #H0000,16

Example:

BB:WLAN:PSDU:MAC:FORM #HA5A5,16
sets the value of the duration Id field.

[:SOURCE<hw>]:BB:WLAN:PSDU:MAC:FCONTROL <FControl>

The command enters the value of the frame control field. The Frame control field has a length of 2 bytes (16 bits) and is used to define the protocol version, the frame type and its function, etc.. As an alternative, the individual bits can be set with the following commands.

The MAC header can only be configured in framed mode (SOURCE:BB:WLAN:SMODE FRAMED).

Parameters:

<FControl> integer
Range: #H0000,16 to #FFFFFF,16
*RST: #H0000,16

Example:

BB:WLAN:PSDU:MAC:FCON #H100A,16
sets the value of the frame control field.

[:SOURCE<hw>]:BB:WLAN:PSDU:MAC:FCONTROL:FDS <Fds>

```

[:SOURCE<hw>]:BB:WLAN:PSDU:MAC:FCONTrol:MDATa <Mdata>
[:SOURCE<hw>]:BB:WLAN:PSDU:MAC:FCONTrol:MFRagments <Mfragments>
[:SOURCE<hw>]:BB:WLAN:PSDU:MAC:FCONTrol:ORDer <Order>
[:SOURCE<hw>]:BB:WLAN:PSDU:MAC:FCONTrol:PMANagement <Pmanagement>
[:SOURCE<hw>]:BB:WLAN:PSDU:MAC:FCONTrol:PVERsion <PVersion>
[:SOURCE<hw>]:BB:WLAN:PSDU:MAC:FCONTrol:RETRy <Retry>
[:SOURCE<hw>]:BB:WLAN:PSDU:MAC:FCONTrol:SUBType <Subtype>
[:SOURCE<hw>]:BB:WLAN:PSDU:MAC:FCONTrol:TDS <Tds>
[:SOURCE<hw>]:BB:WLAN:PSDU:MAC:FCONTrol:TYPE <Type>
[:SOURCE<hw>]:BB:WLAN:PSDU:MAC:FCONTrol:WEP <Wep>

```

The command enters the value of the individual bits of the frame control field.

The MAC header can only be configured in framed mode (SOURCE:BB:WLAN:SMODE FRAMED).

Parameters:

<Wep>	integer	
	Range:	#H0,1 to #H1,1
	*RST:	#H0,1
<Fds> <Mdata> <Mfragments> <Order> <Pmanagement> <Pversion> <Retry> <TDS>	integer	
	Range:	#H0,1 to #H1,1
	*RST:	#H0,1
<Subtype>	integer	
	Range:	#H0,4 to #HF,4
	*RST:	#H0,1
<Type>	integer	
	Range:	#H0,2 to #H3,2
	*RST:	#H0,1

Example: BB:WLAN:PSDU:MAC:FCON:WEP #H1,1
sets the value of the More Data bit.

```
[:SOURCE<hw>]:BB:WLAN:PSDU:MAC:FCSequence:STATe <State>
```

Activates/deactivates the calculation of the FCS (frame check sequence). The standard defines a 32-bit (4-byte) check sum to protect the MAC header and the user data (frame body).

The command is only available in framed mode (SOURCE:BB:WLAN:SMODE FRAMED).

Parameters:

<State> 0|1|OFF|ON

Range: #H0000,16 to #HFFFF,16
 *RST: OFF

Example:

BB:WLAN:PSDU:MAC:FCS:STAT ON
 activates the calculation of the FCS.

[:SOURCE<hw>]:BB:WLAN:PSDU:MAC:SCONtrol:FRAGment:INCRement
 <Increment>

Defines the number of packets required to increment the counter of the fragment bits of the sequence control.

The MAC header can only be configured in framed mode (SOURCE:BB:WLAN:SMODE FRAMED).

Parameters:

<Increment> float

Range: 0 to 1024
 *RST: 1

Example:

BB:WLAN:PSDU:MAC:SCON:FRAG:INCR 2
 two packets are required to increment the counter of the fragment bits.

[:SOURCE<hw>]:BB:WLAN:PSDU:MAC:SCONtrol:FRAGment:STARt <Start>

The command enters the start number of the fragment bits of the sequence control.

The MAC header can only be configured in framed mode (SOURCE:BB:WLAN:SMODE FRAMED).

Parameters:

<Start> integer

Range: #H0,4 to #HF,4
 *RST: #H0,04

Example:

BB:WLAN:PSDU:MAC:SCON:FRAG:STAR #H4,4
 sets the start value of the fragment bits of the sequence control.

[:SOURCE<hw>]:BB:WLAN:PSDU:MAC:SCONtrol:SEQUence:INCRement
 <Increment>

Defines the number of packets required to increment the counter of the sequence bits of the sequence control.

The MAC header can only be configured in framed mode (SOURCE:BB:WLAN:SMODE FRAMED).

Parameters:

<Increment> float
 Range: 0 to 1024
 *RST: 1

Example:

BB:WLAN:PSDU:MAC:SCON:FRAG:INCR 2
 two packets are required to increment the counter of the sequence bits.

[:SOURCE<hw>]:BB:WLAN:PSDU:MAC:SCONTROL:SEQUENCE:START <Start>

The command enters the start number of the fragment bits of the sequence control.

The MAC header can only be configured in framed mode (SOURCE:BB:WLAN:SMODE FRAMED).

Parameters:

<Start> integer
 Range: #H0,12 to #HFFF,12
 *RST: #H0,12

Example:

BB:WLAN:PSDU:MAC:SCON:SEQ:STAR #H4,4
 sets the start value of the sequence bits of the sequence control.

[:SOURCE<hw>]:BB:WLAN:PSDU:MAC:SCONTROL:STATE <State>

The command activates/deactivates the sequence control.

The MAC header can only be configured in framed mode (SOURCE:BB:WLAN:SMODE FRAMED).

Parameters:

<State> 0|1|OFF|ON
 *RST: OFF

Example:

BB:WLAN:PSDU:MAC:SCON:STAT ON
 activates the sequence control field.

[:SOURCE<hw>]:BB:WLAN:PSDU:MAC:STATE <State>

The command activates/deactivates the generation of the MAC Header.

The MAC header can only be configured in framed mode (SOURCE:BB:WLAN:SMODE FRAMED).

Parameters:

<State> 0|1|OFF|ON
 *RST: OFF

Example:

BB:WLAN:PSDU:MAC:SCON:STAT ON
 activates the generation of the MAC Header.

[:SOURce<hw>]:BB:WLAN:PSDU:MODulation?

The command queries the modulation type. The modulation mode depends on the selected PSDU bit rate which depends on the selected physical layer mode (SOURce:BB:WLAN:MODE).

Return values:

<Modulation> BPSK|QPSK|QAM16|QAM64|DBPSK|DQPSK|CCK|PBCC

Example:

BB:WLAN:PSDU:MOD?
 queries the modulation mode.
 Response: "DQPSK"

Usage:

Query only

[:SOURce<hw>]:BB:WLAN:PSDU:SCOunt <Scount>

The command sets the number of data symbols. If the number of OFDM data symbols is changed, the generator calculates the data field length as a function of the set PSDU bit rate.

The command is only available in physical layer mode OFDM (SOURce:BB:WLAN:MODE OFDM).

If the number of OFDM data symbols is changed, the generator calculates the data field length (SOUR:BB:WLAN:PSDU:DLEN) as a function of the set PSDU bit rate.

Parameters:

<Scount> float
 Range: 1 to 1378
 *RST: 4

Example:

BB:WLAN:PSDU:SCO 256
 sets the number of data symbols to 256.

List of Commands

[SOURce<hw>]:BB:WLAN:CLIPping:LEVel.....	58
[SOURce<hw>]:BB:WLAN:CLIPping:MODE.....	58
[SOURce<hw>]:BB:WLAN:CLIPping:STATe.....	58
[SOURce<hw>]:BB:WLAN:CLOCK:MODE.....	74
[SOURce<hw>]:BB:WLAN:CLOCK:MULTIplier.....	75
[SOURce<hw>]:BB:WLAN:CLOCK:SOURce.....	75
[SOURce<hw>]:BB:WLAN:CLOCK:SYNChronization:EXECute.....	76
[SOURce<hw>]:BB:WLAN:CLOCK:SYNChronization:MODE.....	76
[SOURce<hw>]:BB:WLAN:CRATE:VARiation.....	62
[SOURce<hw>]:BB:WLAN:FFORmat.....	49
[SOURce<hw>]:BB:WLAN:FILTer:ILENght.....	59
[SOURce<hw>]:BB:WLAN:FILTer:ILENght:AUTO.....	59
[SOURce<hw>]:BB:WLAN:FILTer:OSAMpling.....	60
[SOURce<hw>]:BB:WLAN:FILTer:OSAMpling:AUTO.....	60
[SOURce<hw>]:BB:WLAN:FILTer:PARAmeter:APCO25.....	60
[SOURce<hw>]:BB:WLAN:FILTer:PARAmeter:COsine.....	60
[SOURce<hw>]:BB:WLAN:FILTer:PARAmeter:GAUSSs.....	61
[SOURce<hw>]:BB:WLAN:FILTer:PARAmeter:LPASSs.....	61
[SOURce<hw>]:BB:WLAN:FILTer:PARAmeter:LPASSEVM.....	61
[SOURce<hw>]:BB:WLAN:FILTer:PARAmeter:PGAuss.....	62
[SOURce<hw>]:BB:WLAN:FILTer:PARAmeter:RCOSine.....	62
[SOURce<hw>]:BB:WLAN:FILTer:PARAmeter:SPHase.....	62
[SOURce<hw>]:BB:WLAN:FILTer:TYPE.....	59
[SOURce<hw>]:BB:WLAN:ILEaver:STATe.....	50
[SOURce<hw>]:BB:WLAN:ITIME.....	50
[SOURce<hw>]:BB:WLAN:MODE.....	50
[SOURce<hw>]:BB:WLAN:PLCP:FORMat.....	51
[SOURce<hw>]:BB:WLAN:PLCP:LCBit:STATe.....	51
[SOURce<hw>]:BB:WLAN:PRESet.....	52
[SOURce<hw>]:BB:WLAN:PSDU:BRATE.....	78
[SOURce<hw>]:BB:WLAN:PSDU:BSPrEading:STATe.....	78
[SOURce<hw>]:BB:WLAN:PSDU:DATA.....	78
[SOURce<hw>]:BB:WLAN:PSDU:DATA:DSElect.....	79
[SOURce<hw>]:BB:WLAN:PSDU:DATA:PATTern.....	79
[SOURce<hw>]:BB:WLAN:PSDU:DLENght.....	80
[SOURce<hw>]:BB:WLAN:PSDU:MAC:ADDRess<ch>.....	80
[SOURce<hw>]:BB:WLAN:PSDU:MAC:ADDRess<ch>:STATe.....	80
[SOURce<hw>]:BB:WLAN:PSDU:MAC:DID.....	81
[SOURce<hw>]:BB:WLAN:PSDU:MAC:FCONtrol.....	81
[SOURce<hw>]:BB:WLAN:PSDU:MAC:FCONtrol:FDS.....	81
[SOURce<hw>]:BB:WLAN:PSDU:MAC:FCONtrol:MDATa.....	82
[SOURce<hw>]:BB:WLAN:PSDU:MAC:FCONtrol:MFRagments.....	82
[SOURce<hw>]:BB:WLAN:PSDU:MAC:FCONtrol:ORDER.....	82
[SOURce<hw>]:BB:WLAN:PSDU:MAC:FCONtrol:PMANagement.....	82
[SOURce<hw>]:BB:WLAN:PSDU:MAC:FCONtrol:PVERsion.....	82
[SOURce<hw>]:BB:WLAN:PSDU:MAC:FCONtrol:RETRy.....	82
[SOURce<hw>]:BB:WLAN:PSDU:MAC:FCONtrol:SUBType.....	82

[SOURce<hw>]:BB:WLAN:PSDU:MAC:FCONtrol:TDS.....	82
[SOURce<hw>]:BB:WLAN:PSDU:MAC:FCONtrol:TYPE.....	82
[SOURce<hw>]:BB:WLAN:PSDU:MAC:FCONtrol:WEP.....	82
[SOURce<hw>]:BB:WLAN:PSDU:MAC:FCSequence:STATe.....	82
[SOURce<hw>]:BB:WLAN:PSDU:MAC:SCONtrol:FRAGment:INCRement.....	83
[SOURce<hw>]:BB:WLAN:PSDU:MAC:SCONtrol:FRAGment:STARt.....	83
[SOURce<hw>]:BB:WLAN:PSDU:MAC:SCONtrol:SEQUence:INCRement.....	83
[SOURce<hw>]:BB:WLAN:PSDU:MAC:SCONtrol:SEQUence:STARt.....	84
[SOURce<hw>]:BB:WLAN:PSDU:MAC:SCONtrol:STATe.....	84
[SOURce<hw>]:BB:WLAN:PSDU:MAC:STATe.....	84
[SOURce<hw>]:BB:WLAN:PSDU:MODulation.....	85
[SOURce<hw>]:BB:WLAN:PSDU:SCOunt.....	85
[SOURce<hw>]:BB:WLAN:SCRambler:MODE.....	52
[SOURce<hw>]:BB:WLAN:SCRambler:PATtern.....	53
[SOURce<hw>]:BB:WLAN:SERVice[:PATtern].....	53
[SOURce<hw>]:BB:WLAN:SETTing:CATalog.....	53
[SOURce<hw>]:BB:WLAN:SETTing:DELete.....	54
[SOURce<hw>]:BB:WLAN:SETTing:LOAD.....	54
[SOURce<hw>]:BB:WLAN:SETTing:STORe.....	54
[SOURce<hw>]:BB:WLAN:SLENgth.....	54
[SOURce<hw>]:BB:WLAN:SMODE.....	55
[SOURce<hw>]:BB:WLAN:STANdard.....	55
[SOURce<hw>]:BB:WLAN:STATe.....	56
[SOURce<hw>]:BB:WLAN:TDWindowing:STATe.....	56
[SOURce<hw>]:BB:WLAN:TRIGger:ARM:EXECute.....	63
[SOURce<hw>]:BB:WLAN:TRIGger:EXECute.....	64
[SOURce<hw>]:BB:WLAN:TRIGger:EXTErnal:SYNChronize:OUTPut.....	64
[SOURce<hw>]:BB:WLAN:TRIGger:OBASeband:DELay.....	65
[SOURce<hw>]:BB:WLAN:TRIGger:OBASeband:INHibit.....	65
[SOURce<hw>]:BB:WLAN:TRIGger:OUTPut:DELay:FIXed.....	70
[SOURce<hw>]:BB:WLAN:TRIGger:OUTPut<ch>:DELay.....	70
[SOURce<hw>]:BB:WLAN:TRIGger:OUTPut<ch>:DELay:MAXimum.....	71
[SOURce<hw>]:BB:WLAN:TRIGger:OUTPut<ch>:DELay:MINimum.....	71
[SOURce<hw>]:BB:WLAN:TRIGger:OUTPut<ch>:MODE.....	72
[SOURce<hw>]:BB:WLAN:TRIGger:OUTPut<ch>:OFFTime.....	73
[SOURce<hw>]:BB:WLAN:TRIGger:OUTPut<ch>:ONTime.....	73
[SOURce<hw>]:BB:WLAN:TRIGger:OUTPut<ch>:PATtern.....	73
[SOURce<hw>]:BB:WLAN:TRIGger:OUTPut<ch>:PULSe:DIVider.....	73
[SOURce<hw>]:BB:WLAN:TRIGger:OUTPut<ch>:PULSe:FREQUency.....	74
[SOURce<hw>]:BB:WLAN:TRIGger:RMODE.....	66
[SOURce<hw>]:BB:WLAN:TRIGger:SLENgth.....	66
[SOURce<hw>]:BB:WLAN:TRIGger:SLUNit.....	67
[SOURce<hw>]:BB:WLAN:TRIGger:SOURce.....	67
[SOURce<hw>]:BB:WLAN:TRIGger[:EXTErnal<ch>]:DELay.....	68
[SOURce<hw>]:BB:WLAN:TRIGger[:EXTErnal<ch>]:INHibit.....	68
[SOURce<hw>]:BB:WLAN:TTIME.....	57
[SOURce<hw>]:BB:WLAN[:TRIGger]:SEQUence.....	69

Index

A

Addresses	32
Arm	40
Armed_Auto	69
Armed_Retrigger	69
Arm Trigger – WLAN	63
Auto	69

B

Baseband filter	35, 59
BxT	35
B x T	60

C

CCK mode	21, 50
Chip clock	46
Chip Clock Multiplier	46, 75
Chip Rate Variation	36
Clipping Level	37, 58
Clipping Mode	37, 58
Clock Mode	46, 74
Clock parameters	24
Clock Source	45, 75
Crest factor - Clipping	58
Crest factor – Clipping	37, 58
Current Range without Recalculation	44, 71
Cut Off Frequency Factor	36

D

Data Length	28, 80
Data List Management	29
Data pattern	28
Default settings	19, 52
Delay - Marker	44, 70
Delay - Trigger	68
Delete IEEE 802.11a-g WLAN settings	20, 54
Disable Barker Spreading (CCK,PBCC)	30, 78
Documentation Overview	5
Duration Id	32, 81

E

Edit Data List	29
Execute Trigger	23, 41, 64
External Trigger Delay	68
External Trigger Inhibit	68

F

FCS	34
FCS (checksum)	31, 82
Filter	35
Filter, Clipping	23
Filter Parameter	60
Filter Type	59
Fixed Marker Delay Maximum	71
Fix marker delay to current range	45, 70
Frame Body	34
Frame Control	32, 81, 82

G

Generate Waveform File	20
Global Trigger/Clock Settings	46

I

Idle Time	22
Impulse Length	36, 59
Impulse Length Auto State	59
Increment every	34, 83
Interleaver Active OFDM	30, 50

L

Load IEEE 802.11a-g WLAN settings	20, 54
---	--------

M

Manual Trigger	64
Marker Delay	44, 70
Marker Mode	43, 72
Measured External Clock	46
Multiplier	46, 75

N

Number of Data Symbols	28, 85
Nyquist filter	59

O

OFDM mode	21, 50
ON/OFF Ratio Marker	43, 73
Oversampling	36, 60
Oversampling Auto State	60

P

Pattern	28, 79
PBCC mode	21, 50
Physical Layer Mode	21, 50
PLCP P+H Format (CCK,PBCC)	26, 51
PPDU Configuration	23
PRBS Type	28
Predefined Frames	22, 49
PSDU Bit Rate	
CCK	78
OFDM	78
OFDMPBCC	78
PSDU Bit Rate (CCK,PBCC)	27
PSDU Bit Rate (OFDM)	27
PSDU Data Source	28, 78
PSDU Modulation	27, 85
Pulse Divider Marker	43, 73
Pulse Frequency Marker	43, 74

R

Recall IEEE 802.11a-g WLAN settings	20, 54
Retrigger	69
Roll Off	60
Roll Off Factor	35
Running	40

Running - Trigger 66

S

Sampling Rate Variation 62
 Save-Recall 20, 53
 Save IEEE 802.11a-g WLAN settings 20, 54
 Scrambler 29
 Scrambler Init (hex) OFDM 30, 53
 Scrambler OFDM 29
 Scrambling OFDM 52
 Sequence Configuration 23
 Sequence Control 32, 84
 Sequence Length 22, 54
 Sequence Length - Trigger 66
 Service Field (hex) OFDM 30, 53
 Service Field Clock Bits (CCK,PBCC) 30, 51
 Set Synchronization Settings 45, 76
 Set to default 19, 52
 Signal Duration 40
 Signal Duration - Trigger 40
 Signal Duration Unit - Trigger 67
 Simulation Mode 21, 55
 Single Duration Unit - Trigger 66
 Standard 20, 55
 Standard settings 19, 52
 Start Number 34, 83, 84
 State 19, 56
 State - Clipping 37, 58
 Stopped 40
 Sync. Output to External Trigger 41
 Synchronization mode 45
 Synchronization Mode 76

T

Time Domain Windowing Active OFDM 30, 56
 Transition Time 30, 57
 Trigger Delay 42
 Trigger Delay External 68
 Trigger Delay Other Baseband 65
 Trigger Inhibit 43
 Trigger Inhibit External 68
 Trigger Inhibit Other Baseband 65
 Trigger Mode 69
 Armed 39
 Auto 39
 Retrigger 39
 Single 39
 Trigger parameters 23
 Trigger Source 41, 67

U

User Marker / AUX I/O Settings 47

W

Waveform FileA 20